

MANUAL DE MONTAGEM
Assembly instructions / Instrucciones de armado

MÓDULO PANELEIRO **FLORIPA** - 2160 x 630 x 320

Floripa pantry cabinet - 85"1/6 x 24"13/16 x 12"5/8
Despenser Floripa - 2160 x 630 x 320

Código **170551** | Revisão 01

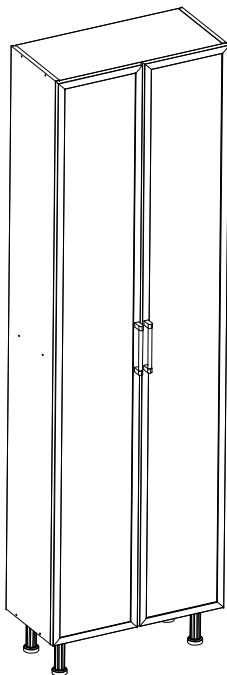

PESO MÁXIMO SUPORTADO PELAS PEÇAS, SENDO ESTE DISTRIBUÍDO UNIFORMEMENTE.

Maximum weight supported by parts, being this evenly distributed.
Peso máximo soportado por las partes, siendo esta distribuido uniformemente.

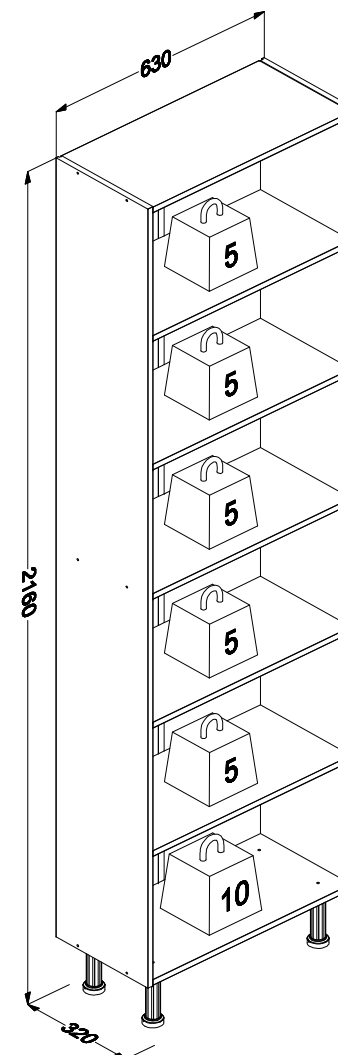

Você vai precisar de/ You will need / Usted necesitará

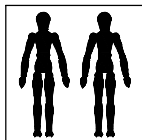

2 Pessoas
2 People
2 Personas

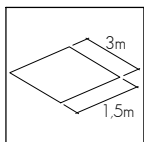

Espaço recomendado para montagem
Recommended space for assemble
Espacio recomendado para el armado

Ferramentas não inclusas
Tools not included / Herramientas no incluidas

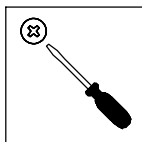

Chave Philips
Screwdriver
Destornillador cruz

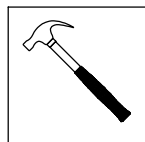

Martelo
Hammer
Martillo

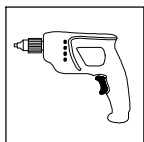

Furadeira
Drill machine
Taladro

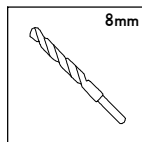









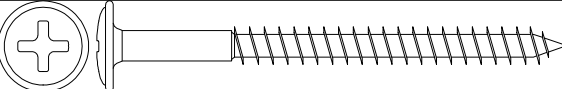
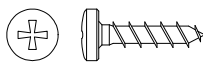

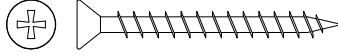
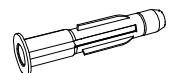
Broca
Drill bit
Taladro

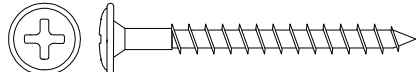
* **PESO EM KG/** Weight in Kg/ **Peso en Kg**
DIMENSÕES EM MM/ Dimensions in mm/ **Dimensiones en mm**

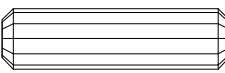
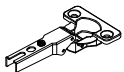
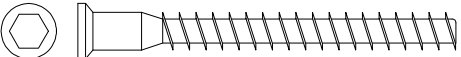
IDENTIFICAÇÃO DOS ACESSÓRIOS/ IDENTIFICATION OF ACCESSORIES/ IDENTIFICACIÓN DE ACCESORIOS

NOTAS: A separação dos acessórios antes de iniciar a montagem facilitará a mesma. Os parafusos e cavilhas estão na escala real. Em caso de dúvida na identificação, coloque o acessório sobre a imagem.
NOTES: The separation of the accessories before you start the assembly will facilitate the same. The screws and dowels are in real scale. In case of doubts about the identification, place the accessory on the image.
NOTAS: La separación de los accesorios antes de comenzar el armado facilitará el mismo. Los tornillos y taquetes son en escala real. En caso de dudas sobre la identificación, coloque el accesorio en la imagen.

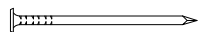
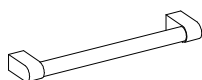
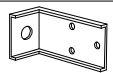
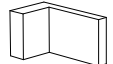
A		Parafuso flangeado Flanged head screw Tornillo de cabeza flangeada	5,0x60 mm	02	S		Parafuso panela Pan head screw Tornillo de pan	3,5x14 mm	04
A6		Perfil "H" "H" profile Perfil "H"	-	01	T8		Parafuso chato Flat head screw Tornillo de cabeza plana	3,5x35 mm	04
B3		Bucha expansiva Bushing Tapón	8x50 mm	02	U3		Pé Rovi Foot Pie	-	04
D4		Parafuso flangeado Flanged head screw Tornillo de cabeza flangeada	4,0x40 mm	04					
D5		Calço dobradiça Hinge shim Bisagra de calce	-	08					
E		Cavilha Wooden Dowel Pin	8x30 mm	28					
F9		Dobradiça reta Metal hinge straight Bisagra recta	26mm	08					
G		Parafuso estrutural Structural screw Tornillo estructural	5,0x50 mm	12					
H		Chave allen Allen key Llave Allen	-	01					
I		Tampa parafuso estrutural Structural screw cover Tapa tornillo estructural	-	12					
L9		Parafuso chato Flat head screw Tornillo de cabeza plana	3,5x12 mm	32					
N		Prego Nail Clavo	10 x10	60					
N1		Puxador Pórtico Handle Tirador	160 mm	02					
N5		Suporte "L" Support "L" Soporte "L"	-	02					
N6		Capa Cover Cubierta	-	02					

IDENTIFICAÇÃO DAS PEÇAS/ PARTS IDENTIFICATION/ IDENTIFICACIÓN DE LAS PIEZAS

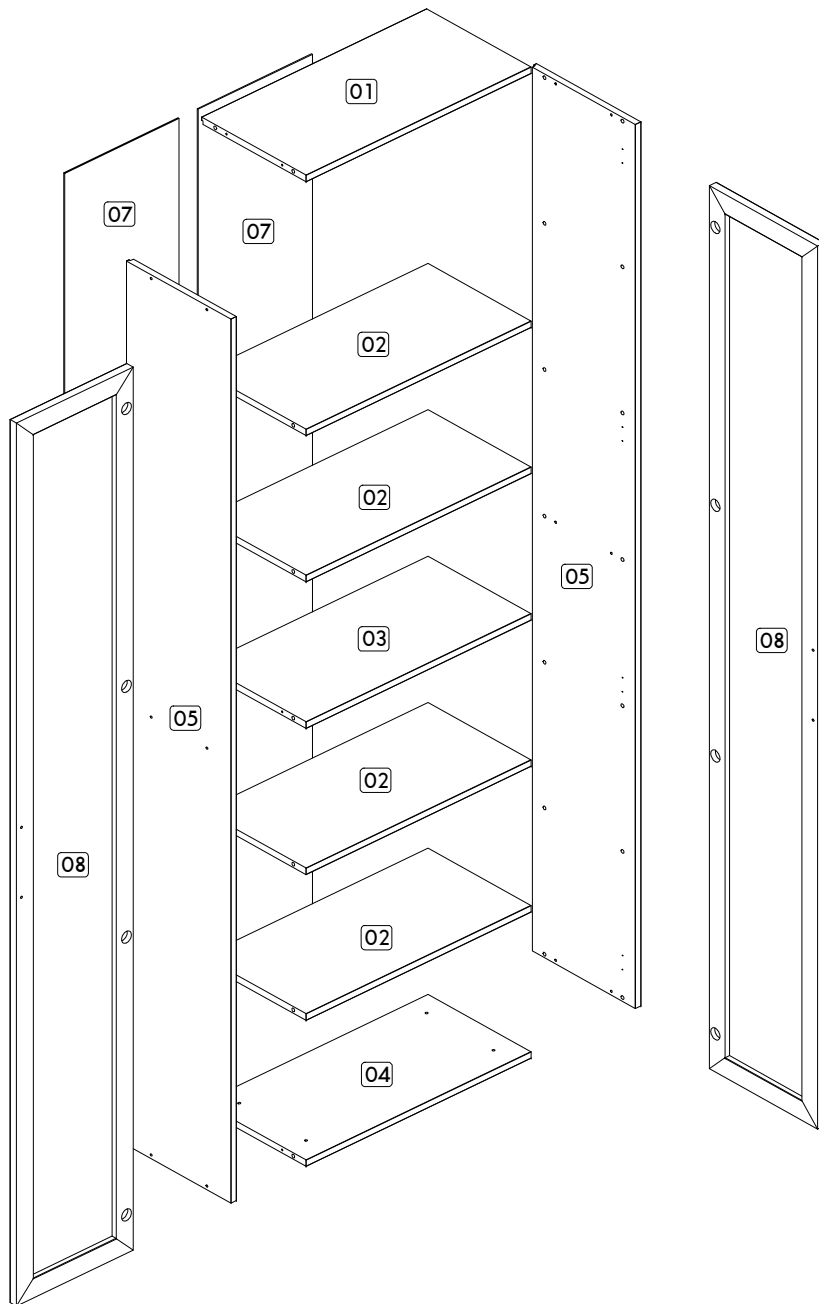

Nº	DESCRIÇÃO - DESCRIPTION - DESCRIPCIÓN	MEDIDAS - MEASURES - MEDIDAS (mm)	QTD.
01	Base superior - Top base - Base superior	600 x 300 x 15	01
02	Prateleira - Shelf - Repisa	600 x 296 x 15	04
03	Base intermediária - Intermediate base - Base intermedia	600 x 296 x 15	01
04	Base inferior - Bottom base - Base inferior	600 x 300 x 15	01
05	Lateral direita/esquerda - Right/left side- Lateral izquierda/derecha	2020 x 300 x 15	02
07	Costa - Back - Fondo	2003 x 305 x 3	02
08	Porta - Door - Puerta	2018 x 311 x 20	02

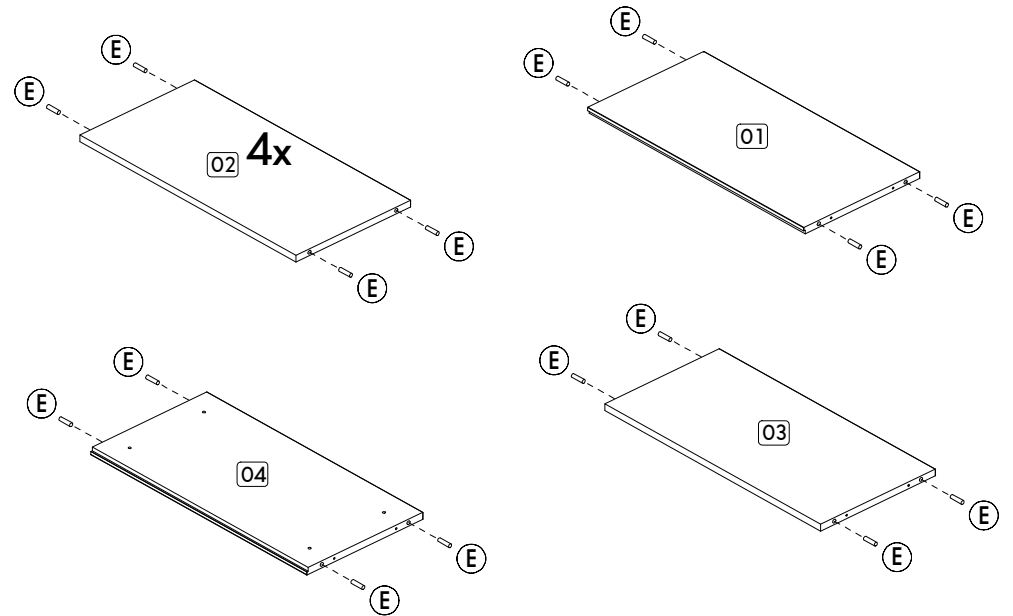
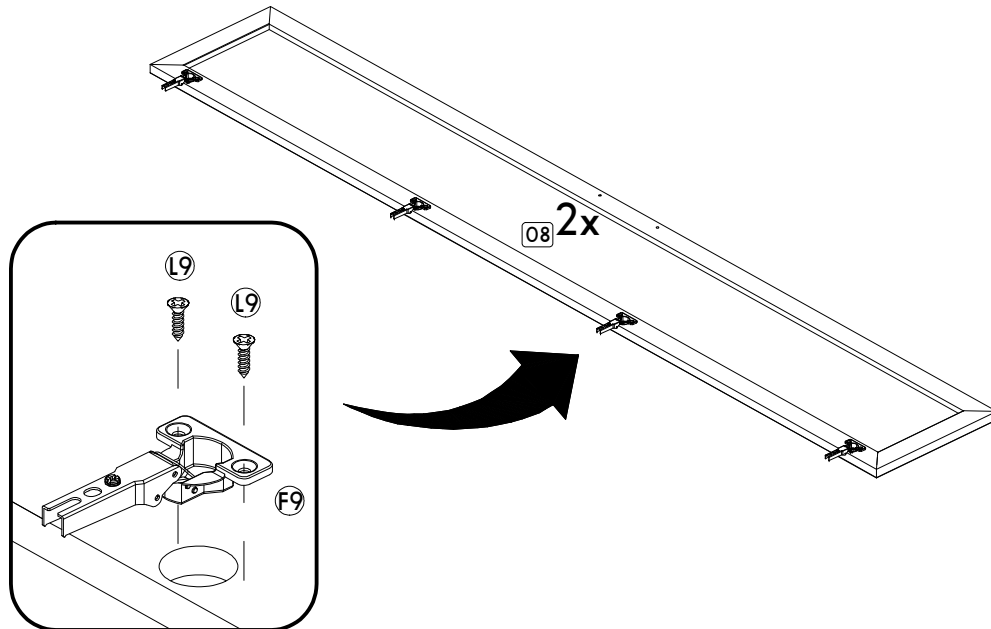
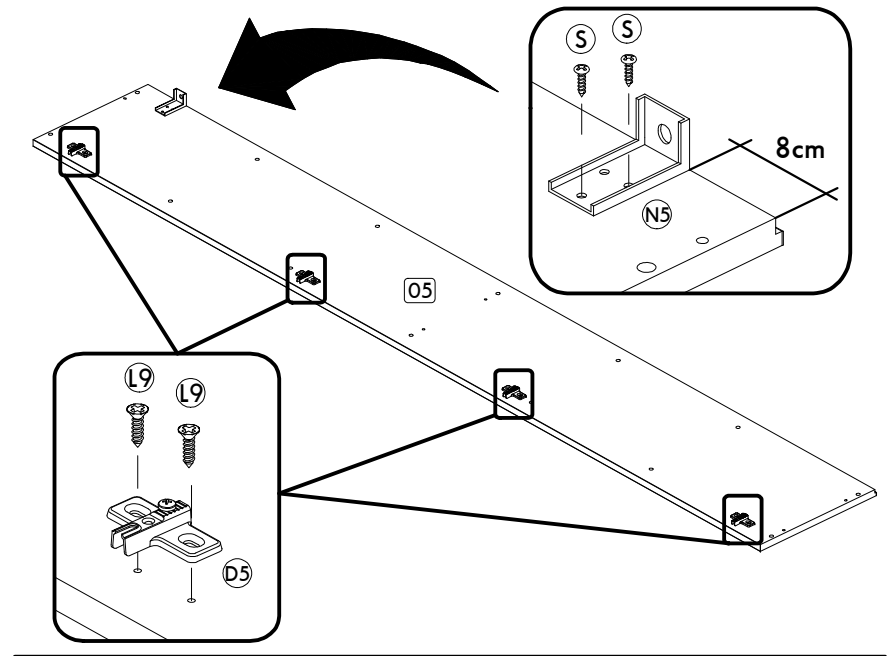
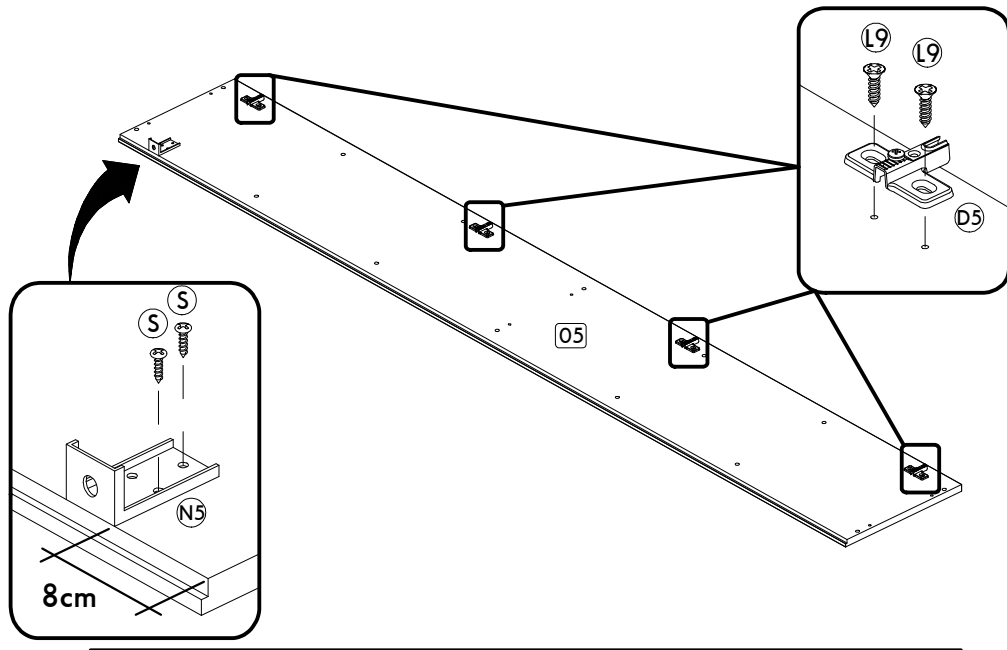

Passo/ Step/ Paso 01

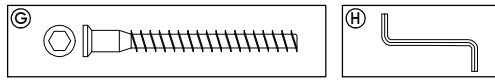
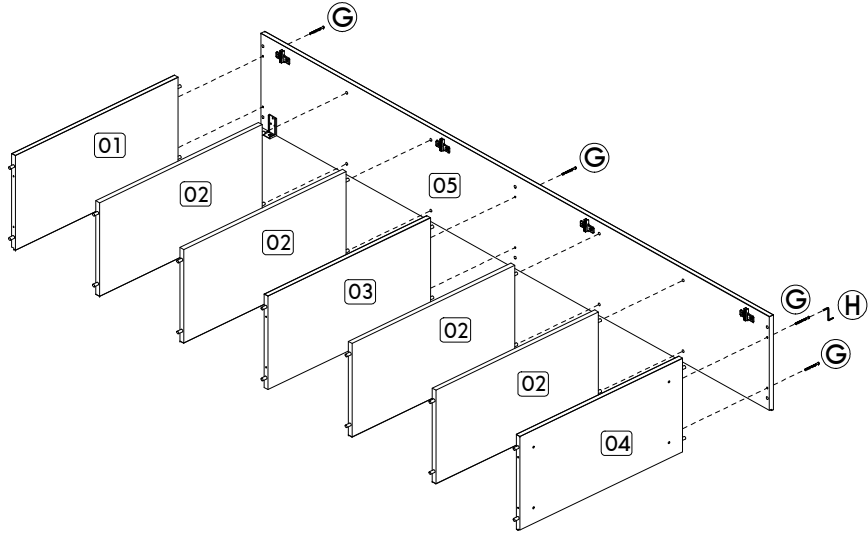

Passo/ Step/ Paso 02

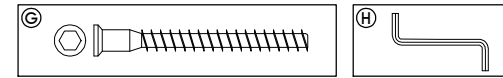
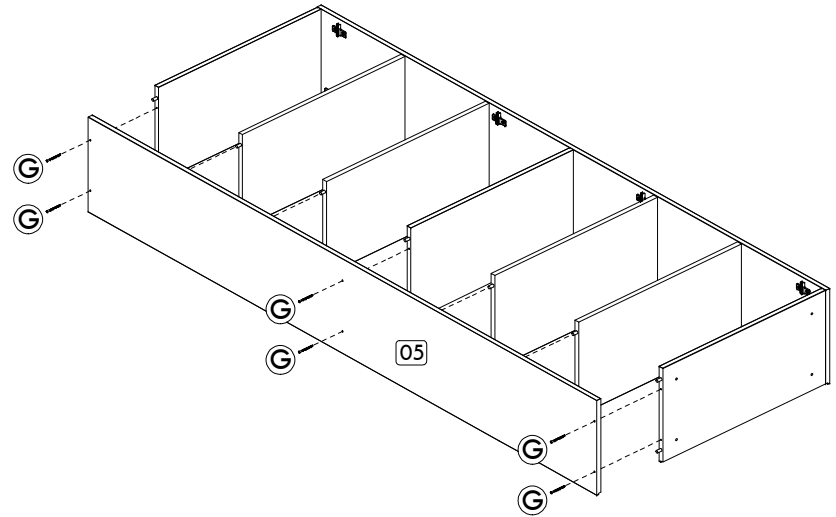

Passo/ Step/ Paso 03

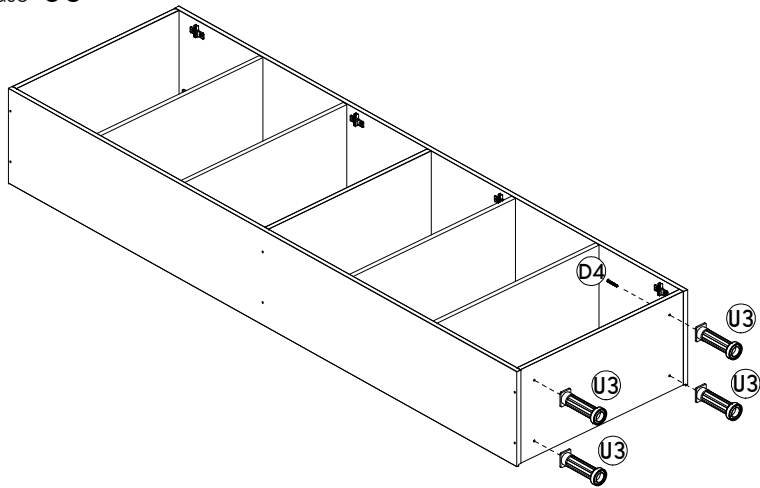

Passo/ Step/ Paso 04

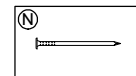
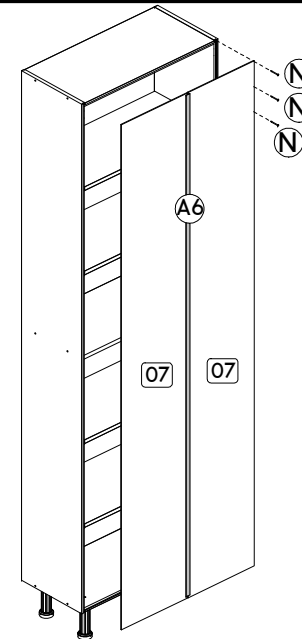

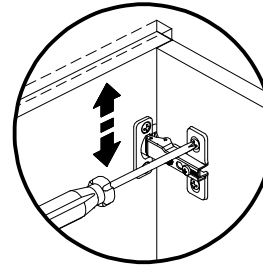
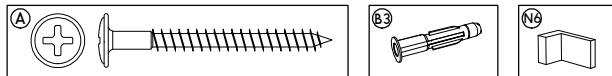
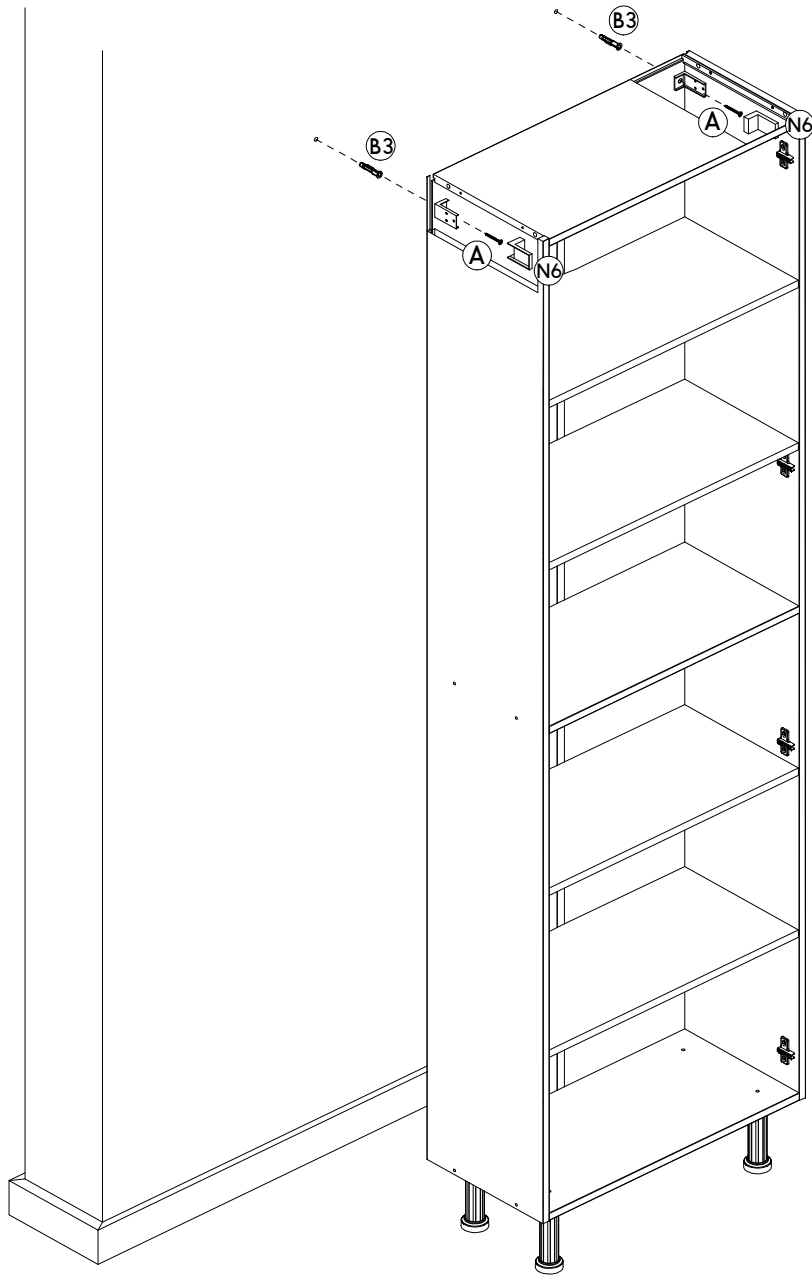

Regulagem Vertical
Ajuste Vertical
Vertical Adjustment

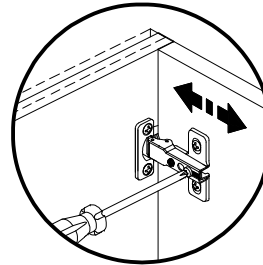

Regulagem Profundidade
Ajuste Profundidad
Depth Adjustment

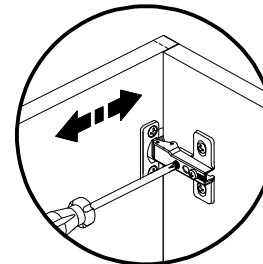

Regulagem Horizontal
Ajuste Horizontal
Horizontal Adjustment

