

MANUAL DE MONTAGEM

ASSEMBLY INSTRUCTIONS / INSTRUCCIONES DE ARMADO

MESA LOS ANGELES - 160CM
 LOS ANGELES office table - 63"
 Escritorio LOS ANGELES - 160cm

Código **180806** | Revisão 00

Português
 English
 Español

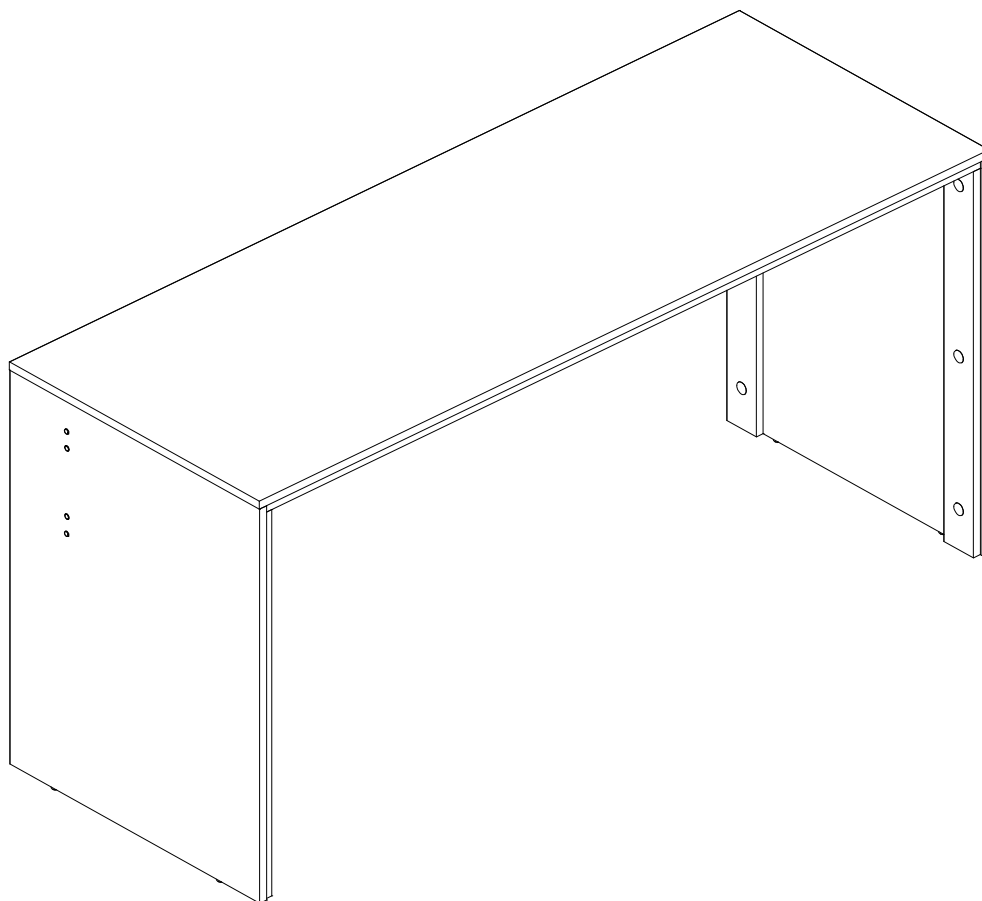

VOCÊ VAI PRECISAR DE / YOU WILL NEED / USTED NECESITARÁ

Ferramentas não fornecidas / Tools not supplied / Herramientas no incluidas

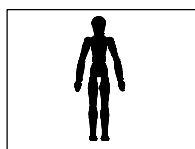

1 Pessoa
 1 Person
 1 Persona

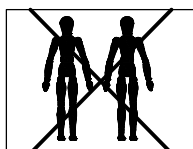

2 Pessoas
 2 People
 2 Personas

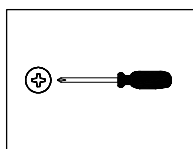

Chave Phillips
 Screwdriver Phillips
 Destornillador cruz

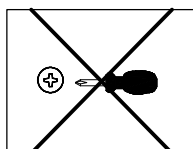

Chave Phillips Menor
 Small screwdriver Phillips
 Destornillador cruz menor

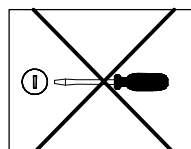

Chave fenda
 Screwdriver slotted
 Destornillador plano

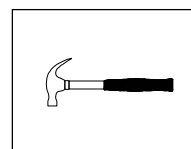

Martelo
 Hammer
 Martillo

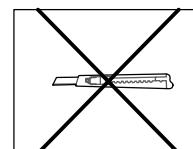

Estilete
 Stylet
 Estilete

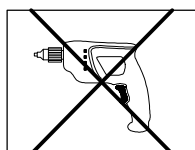

Furadeira
 Drill machine
 Taladro

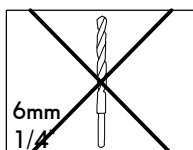

Broca
 Drill bit
 Taladro

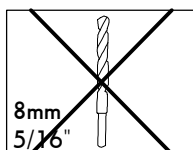

Broca
 Drill bit
 Taladro

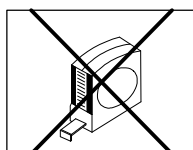

Trena
 Measuring tape
 Cinta de medición

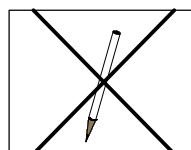









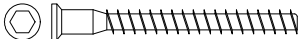

Lápis
 Pencil
 Lápiz

NOTAS: A separação dos acessórios antes de iniciar a montagem facilitará a mesma. Em caso de dúvida no tamanho dos parafusos e cavilhas, utilize a régua ao final da página 2.

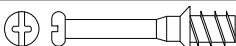
NOTES: The separation of the accessories before you start the assembly will facilitate the same. In case of doubt on the size of the screws and bolts, use the ruler to bottom of page 2.

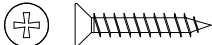
NOTAS: La separación de los accesorios antes de comenzar el armado facilitará el mismo. En caso de duda sobre el tamaño de los tornillos y taquetes, utilice la regla al pie de página 2.

IDENTIFICAÇÃO DOS ACESSÓRIOS/ IDENTIFICATION OF ACCESSORIES/ IDENTIFICACIÓN DE ACCESORIOS

A2		Sapata redonda / Small plastic foot / Pie plástico	14 mm	4
E		Cavilha / Wooden dowel / Taquete	8x30 mm	8
G		Parafuso estrutural / Structural screw / Tornillo estructural	5,0x50 mm	4
H		Chave allen / Allen key / Liave allen	3 mm	1
I		Tampa parafuso estrutural / Structural screw cover / Tapa tornillo estructural	-	4
J		Haste minifix simples / Simple minifix screw / Tornillo minifix simple	-	4
L		Tambor minifix / Drum lock / Tambor minifix	12 mm	4
M		Tapa furo adesivo / Bore patch adhesive / Tapones adhesivo	-	16
M1		Parafuso chato / Flat head screw / Tornillo de cabeza plana	3,5x25 mm	22
N		Prego / Nail / Clavo	10 x10	4
N7		Cavilha / Wooden dowel / Taquete	8x20 mm	14
Z		Tapa furo plástico / Plastic hole plugs / Tapones plásticos	8 mm	4



IDENTIFICAÇÃO DAS PEÇAS / PARTS IDENTIFICATION/ IDENTIFICACIÓN DE LAS PIEZAS

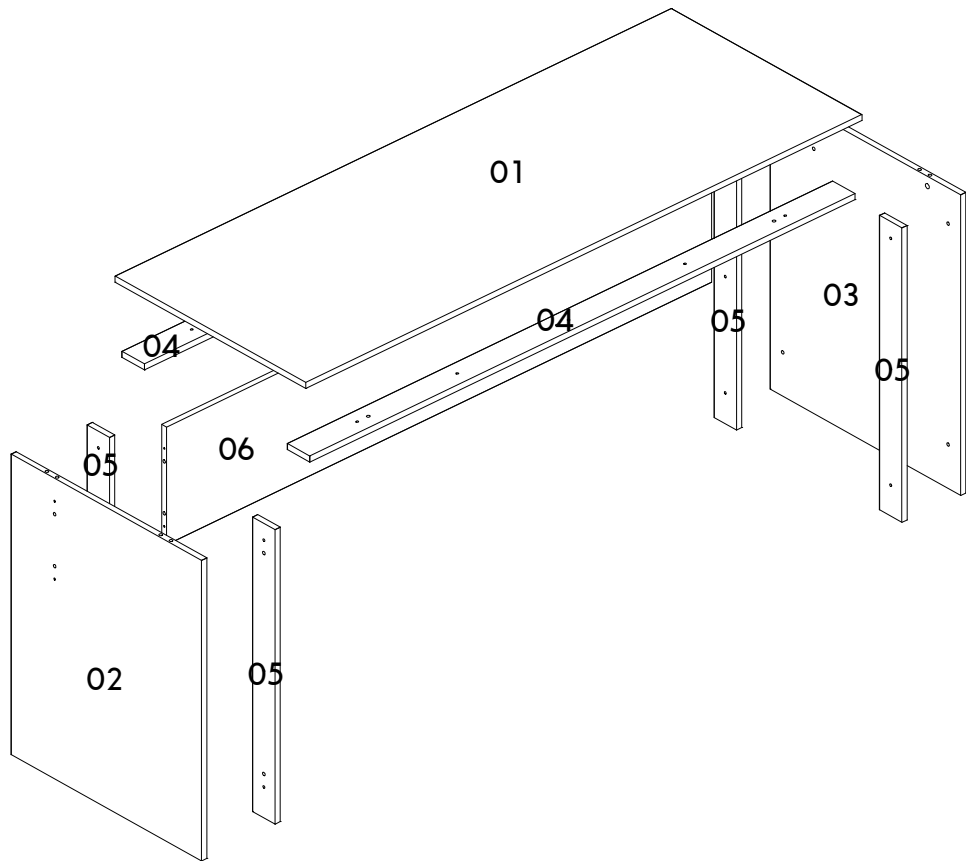

Número / Number / Número	Medidas / Measures / Medidas		Qtd. / Qty. / Qtd.
	cm	inches	
01	160 x 59 x 1,5	63" x 23" 1/4 x 5/8	1
02	74 x 59 x 1,5	29" 1/8 x 23" 1/4 x 5/8	1
03	74 x 59 x 1,5	29" 1/8 x 23" 1/4 x 5/8	1
04	7 x 156,8 x 1,5	2" 3/4 x 61" 3/4 x 5/8	2
05	72,5 x 7 x 1,5	28" 1/2 x 2" 3/4 x 5/8	4
06	29 x 156,8 x 1,5	11" 3/8 x 61" 3/4 x 5/8	1

01

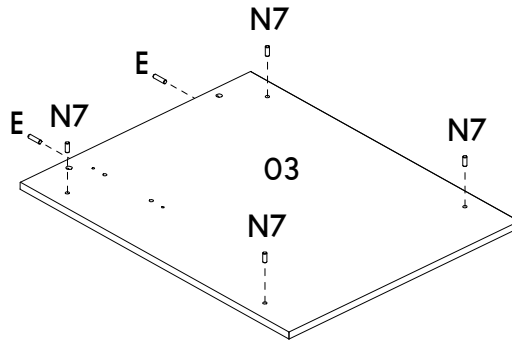
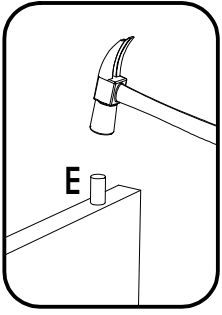

02

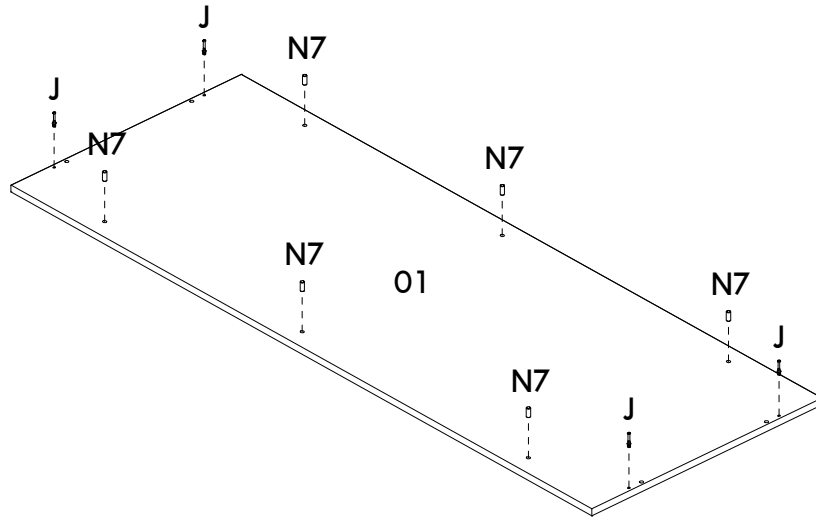
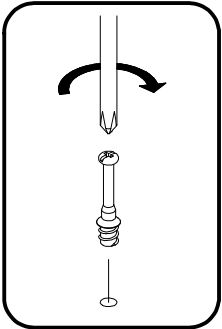

03

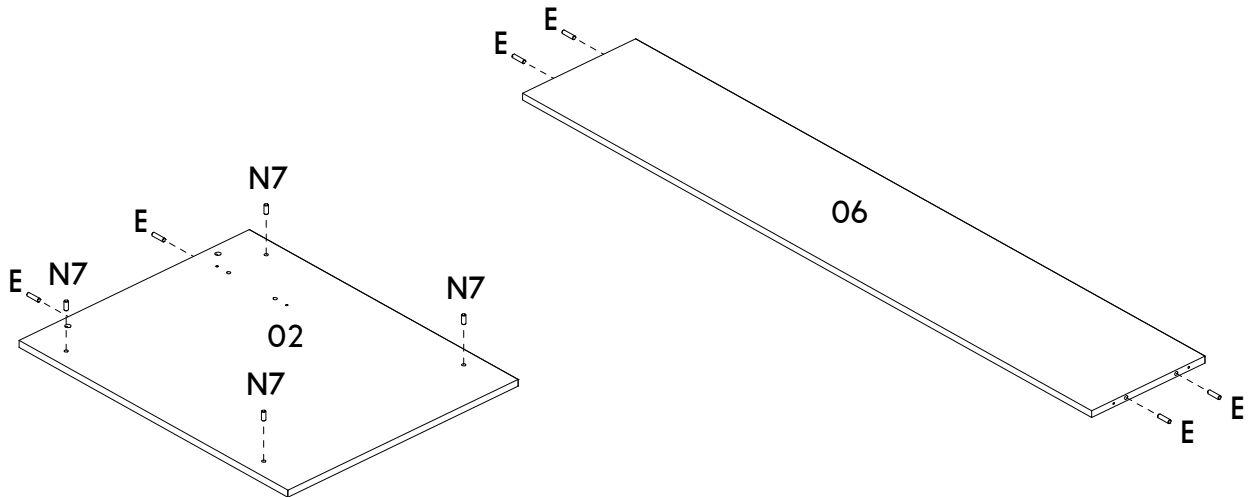

04

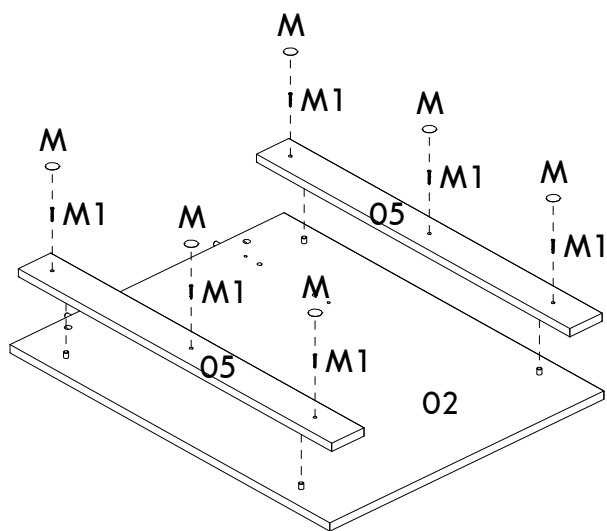

05

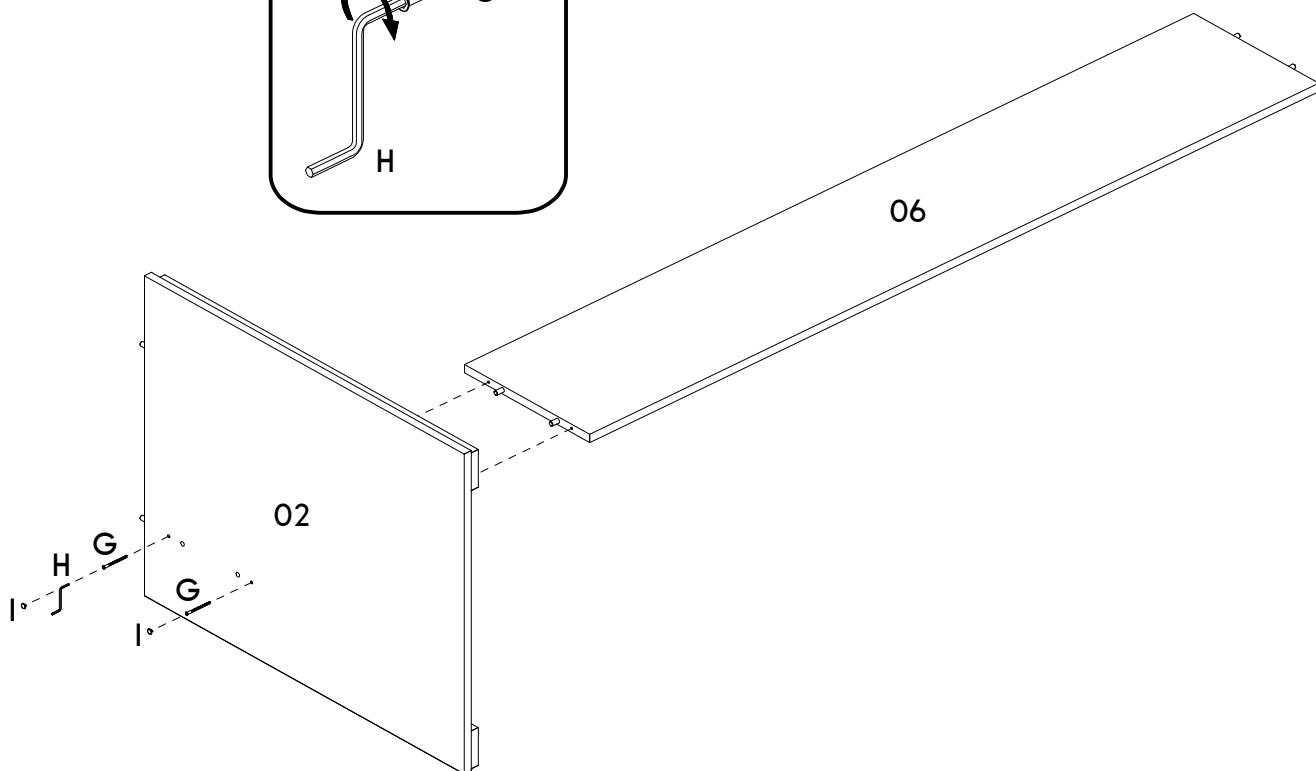
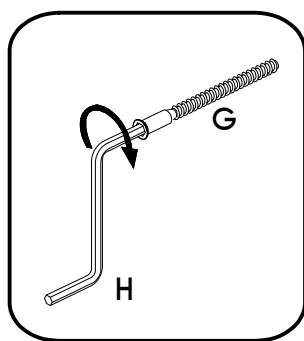

06

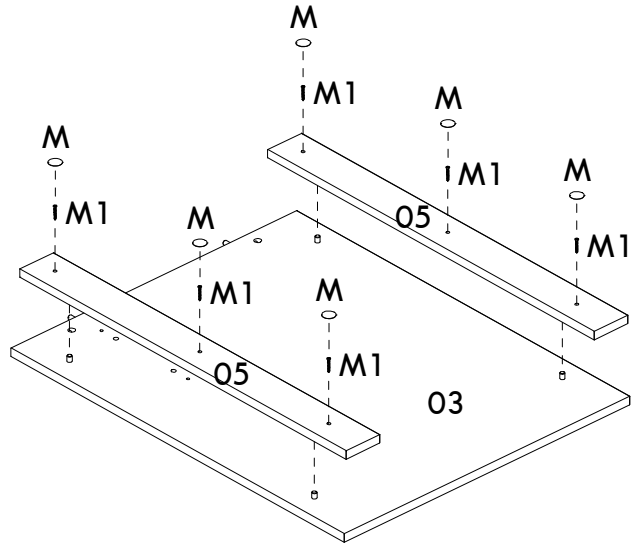

07

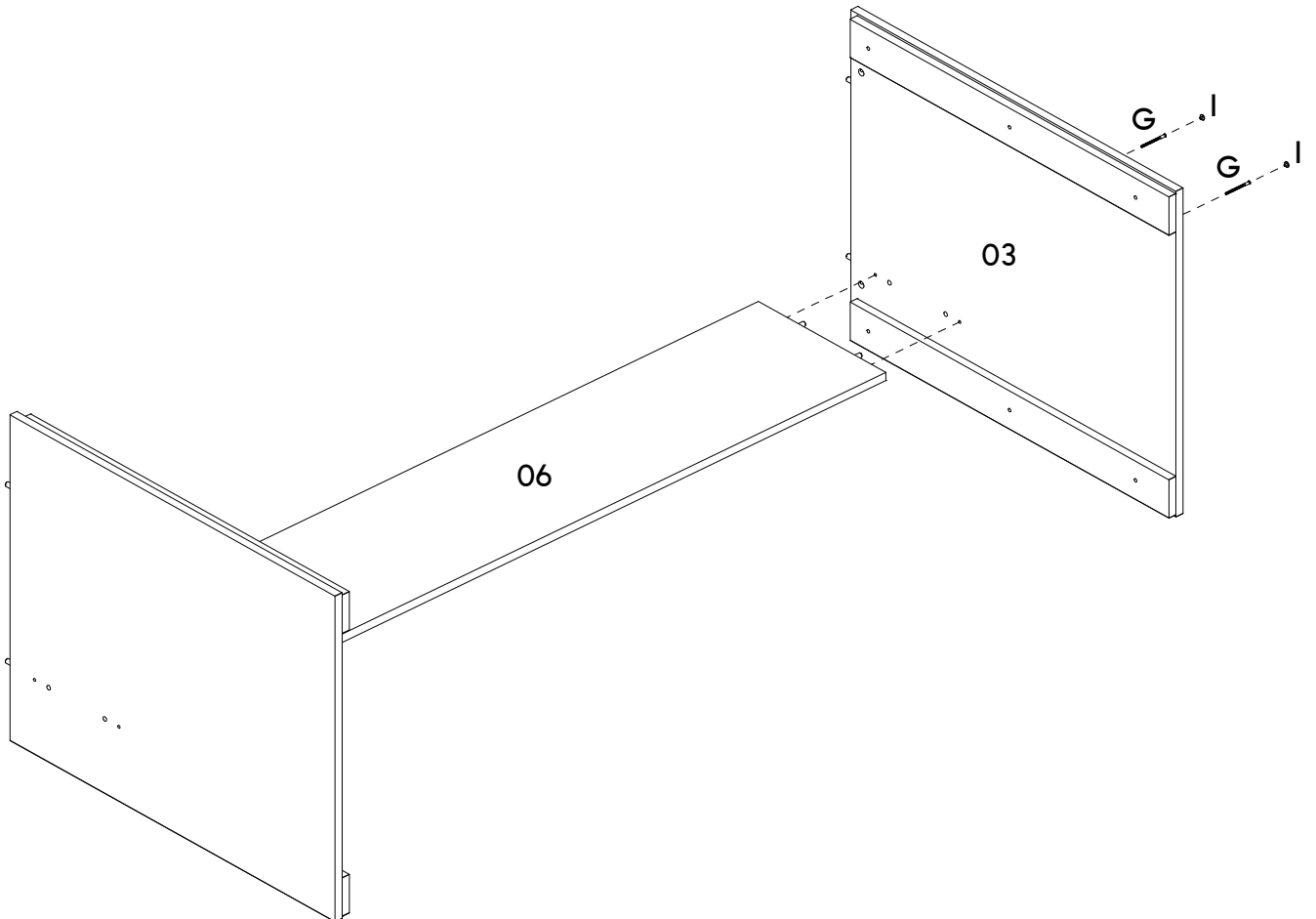

08

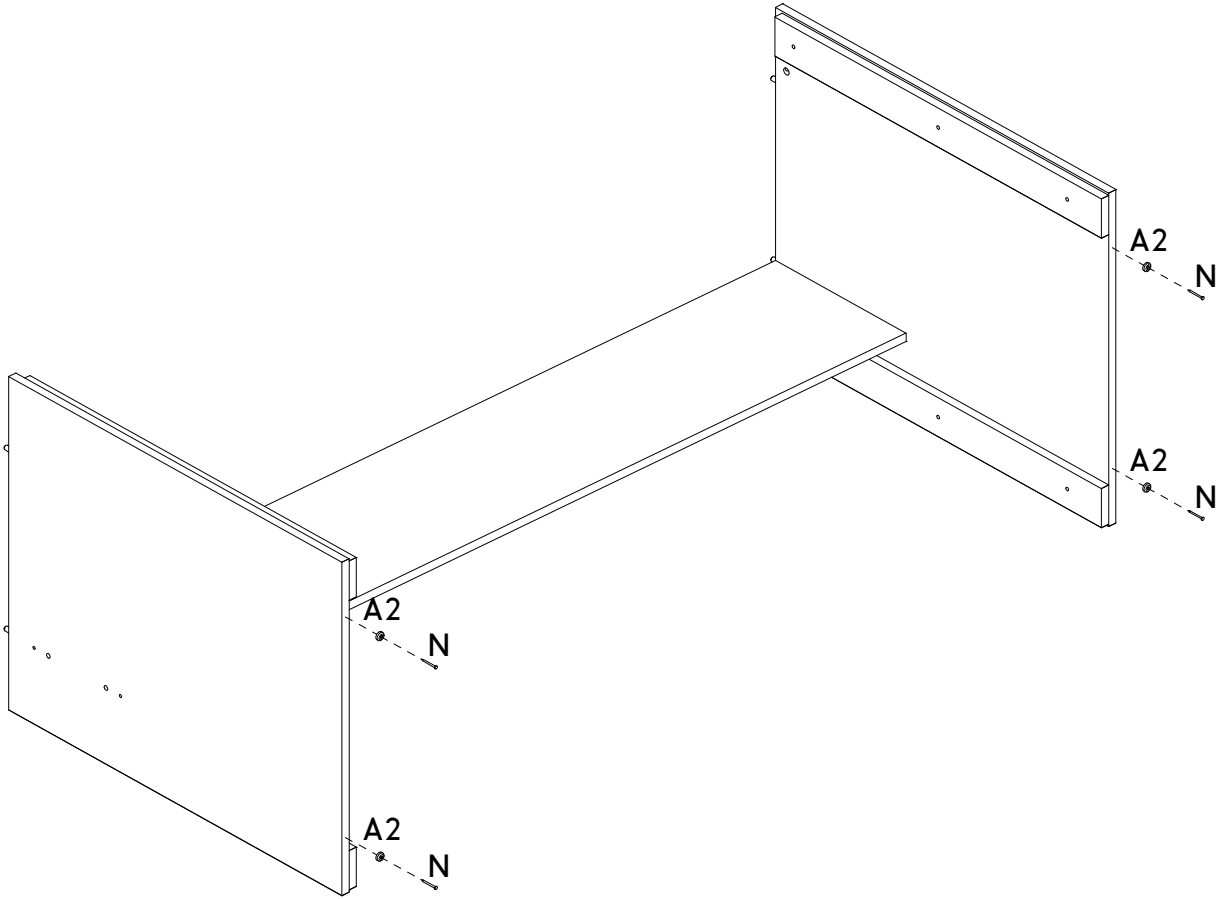

09

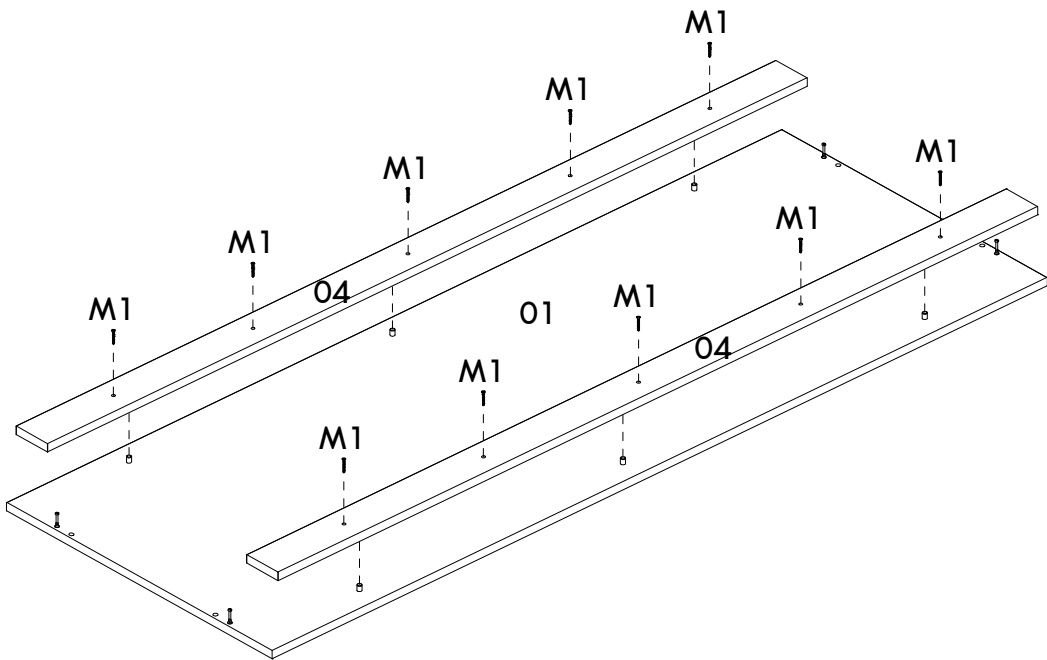

10

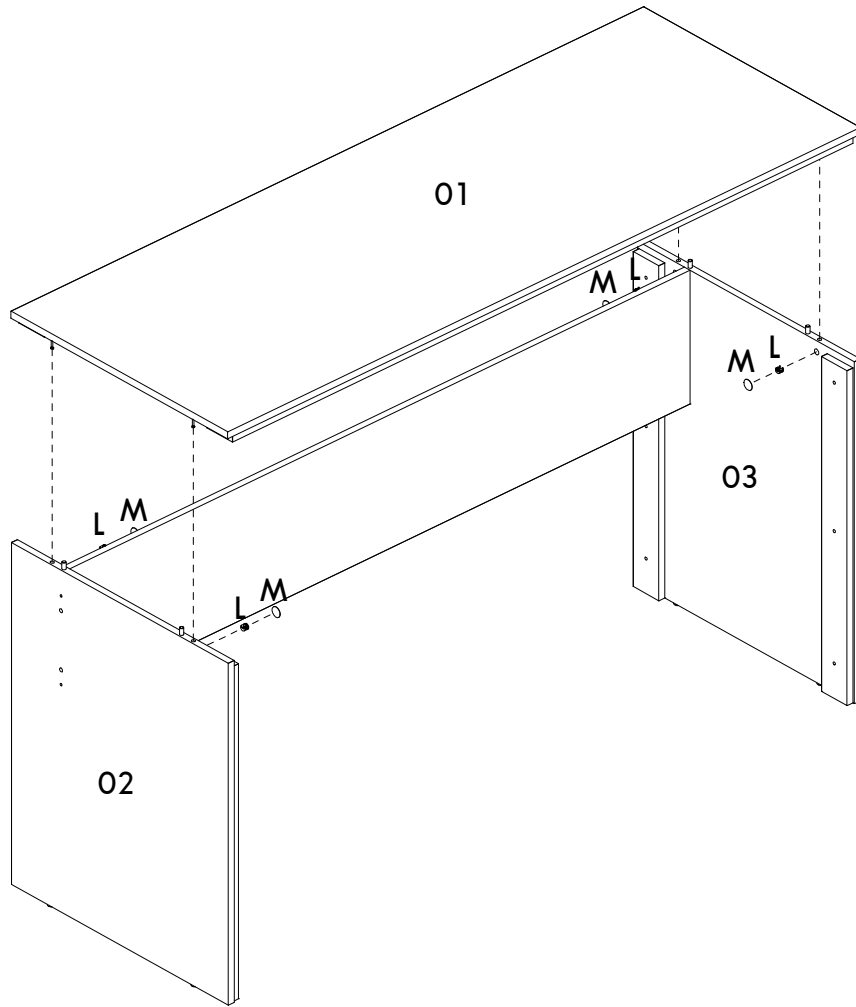
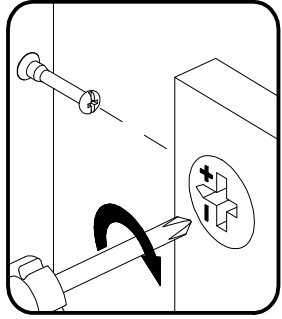

11

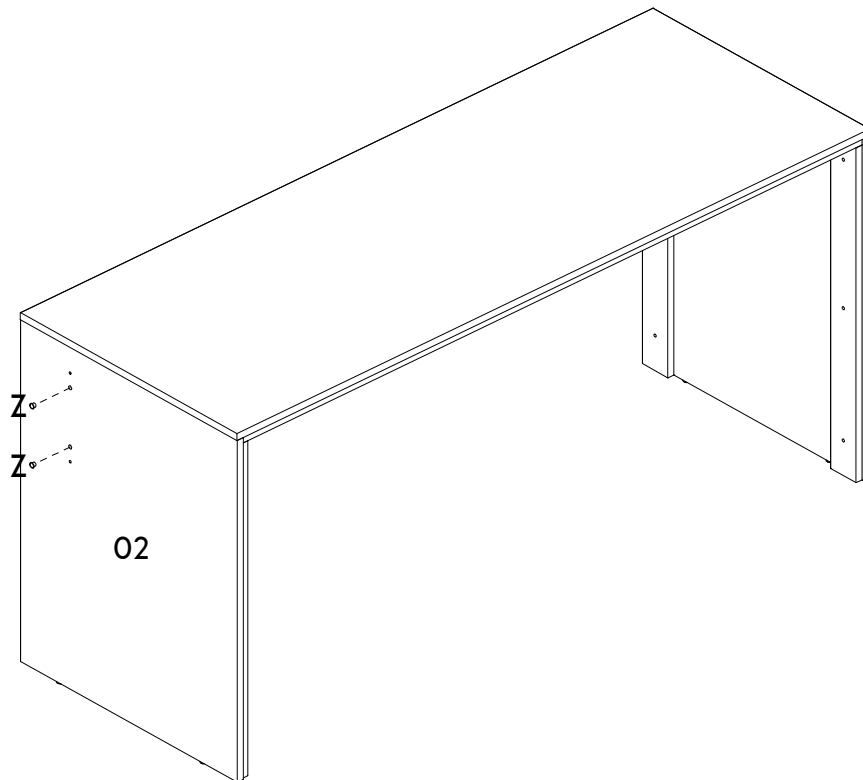

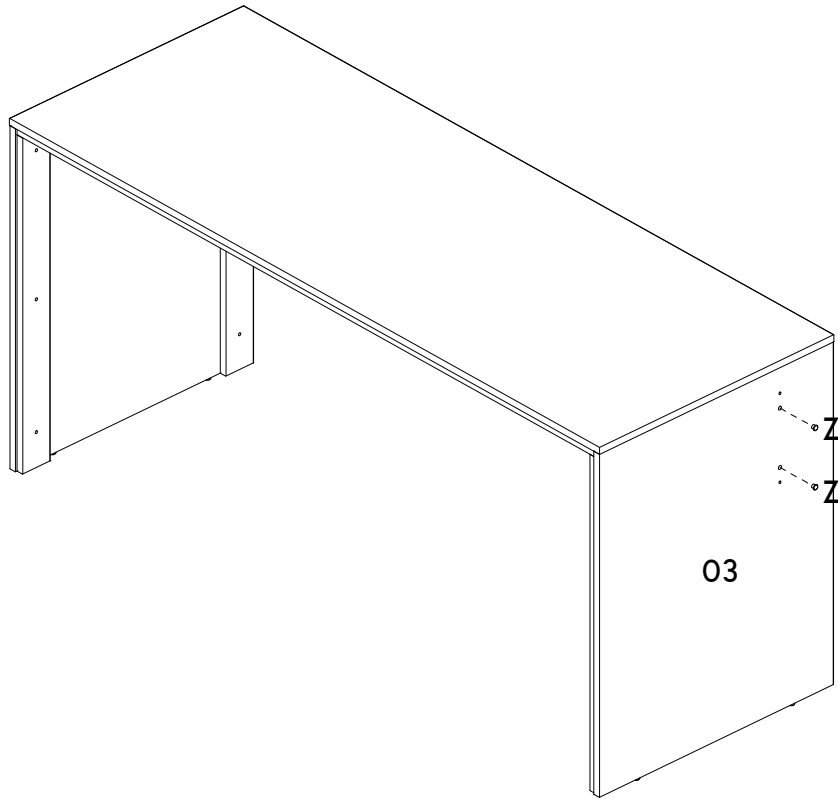

PESO MÁXIMO RECOMENDADO SENDO ESTE DISTRIBUÍDO UNIFORMEMENTE
 MAXIMUM RECOMMENDED WEIGHT BEING THIS EVENLY DISTRIBUTED / PESO MÁXIMO RECOMENDADO SIENDO ESTE UNIFORMEMENTE DISTRIBUIDO

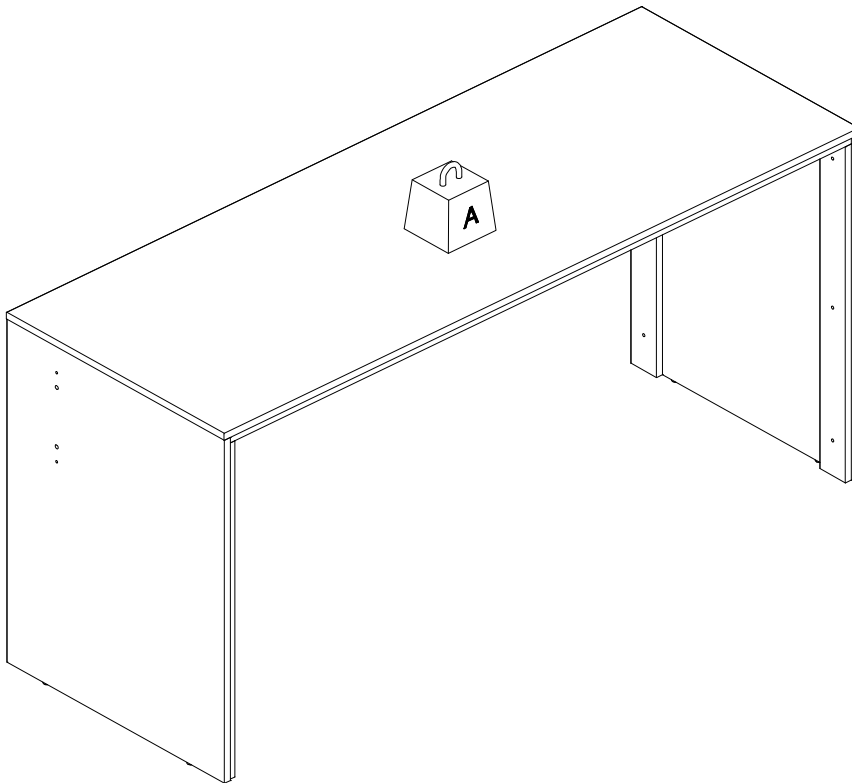

	KG	LB
A	25	55