

MANUAL DE MONTAGEM

ASSEMBLY INSTRUCTIONS / INSTRUCCIONES DE ARMADO

ARMÁRIO NAVEGANTES
 NAVEGANTES cabinet
 Armario NAVEGANTES

Código **180398** | Revisão 00

Português
 English
 Español

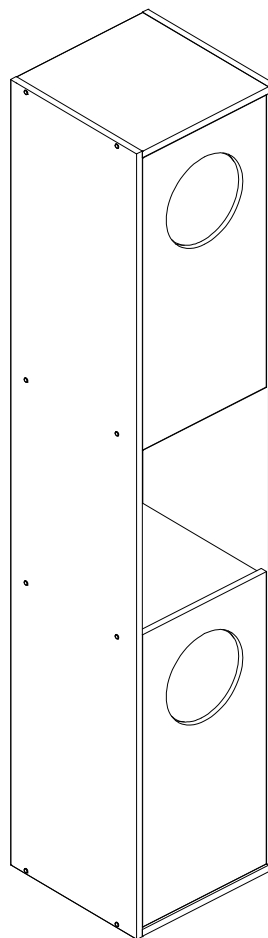
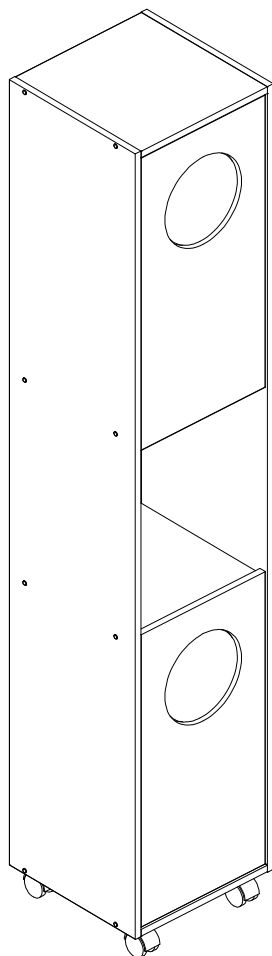

NOTAS: ESSE PRODUTO PODE SER MONTADO COM RODÍZIOS OU FIXADO NA PAREDE.
NOTES: THIS PRODUCT CAN BE ASSEMBLY WITH CASTERS OR FIXED ON THE WALL.
NOTAS: ESTE PRODUCTO PUEDE SER ARMADO CON LAS RUEDAS O FIJADO EN LA PARED.

VOCÊ VAI PRECISAR DE / YOU WILL NEED / USTED NECESITARÁ

Ferramentas não fornecidas / Tools not supplied / Herramientas no incluidas

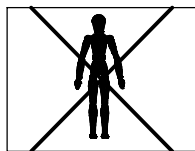

1 Pessoa
 1 Person
 1 Persona

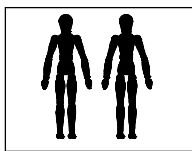

2 Pessoas
 2 People
 2 Personas

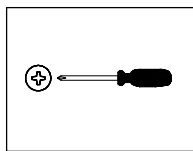

Chave Phillips
 Screwdriver Phillips
 Destornillador cruz

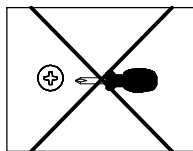

Chave Phillips Menor
 Small screwdriver Phillips
 Destornillador cruz menor

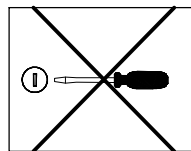

Chave fenda
 Screwdriver slotted
 Destornillador plano

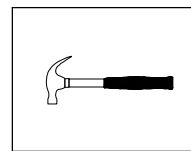

Martelo
 Hammer
 Martillo

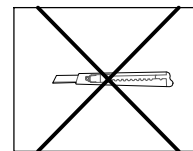

Estilete
 Stylet
 Estilete

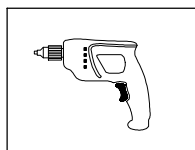

Furadeira
 Drill machine
 Taladro

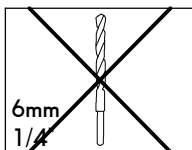

Broca
 Drill bit
 Taladro

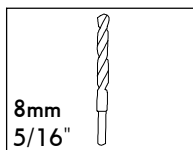

Broca
 Drill bit
 Taladro

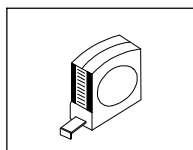

Trena
 Measuring tape
 Cinta de medición

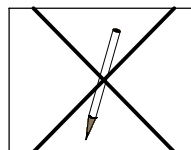











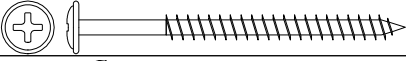
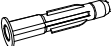

Lápis
 Pencil
 Lápiz

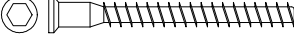
NOTAS: A separação dos acessórios antes de iniciar a montagem facilitará a mesma. Em caso de dúvida no tamanho dos parafusos e cavilhas, utilize a régua ao final da página 2.

NOTES: The separation of the accessories before you start the assembly will facilitate the same. In case of doubt on the size of the screws and bolts, use the ruler to bottom of page 2.

NOTAS: La separación de los accesorios antes de comenzar el armado facilitará el mismo. En caso de duda sobre el tamaño de los tornillos y taquetes, utilice la regla al pie de página 2.

IDENTIFICAÇÃO DOS ACESSÓRIOS/ IDENTIFICATION OF ACCESSORIES/ IDENTIFICACIÓN DE ACCESORIOS

A		Parafuso flangeado / Flanged head screw / Tornillo de cabeza flangeada	5,0x60 mm	4
B3		Bucha expansiva / Bushing / Tapón	8x50 mm	4
D5		Calço dobradiça / Hinge shim / Bisagra de calce	-	4
D6		Dobradiça super alta / Metal hinge super high / Bisagra alta	26 mm	4
E		Cavilha / Wooden dowel / Taquete	8x30 mm	16
E3		Suporte de prateleira / Shelf bracket / Suporte de repisa	8x7 mm	8
G		Parafuso estrutural / Structural screw / Tornillo estrutural	5,0x50 mm	16
H		Chave allen / Allen key / Liave allen	3 mm	1
I		Tampa parafuso estrutural / Structural screw cover / Tapa tornillo estrutural	-	16
K5		Rodízio 50 / Caster / Rueda	-	4
N		Prego / Nail / Clavo	10 x10	40
N5		Suporte "L" / Support "L" / Soporte "L"	-	4
N6		Capa / Cover / Cubierta	-	4
S		Parafuso panela / Pan head screw / Tornillo de pan	3,5x14 mm	40



IDENTIFICAÇÃO DAS PEÇAS / PARTS IDENTIFICATION/ IDENTIFICACIÓN DE LAS PIEZAS

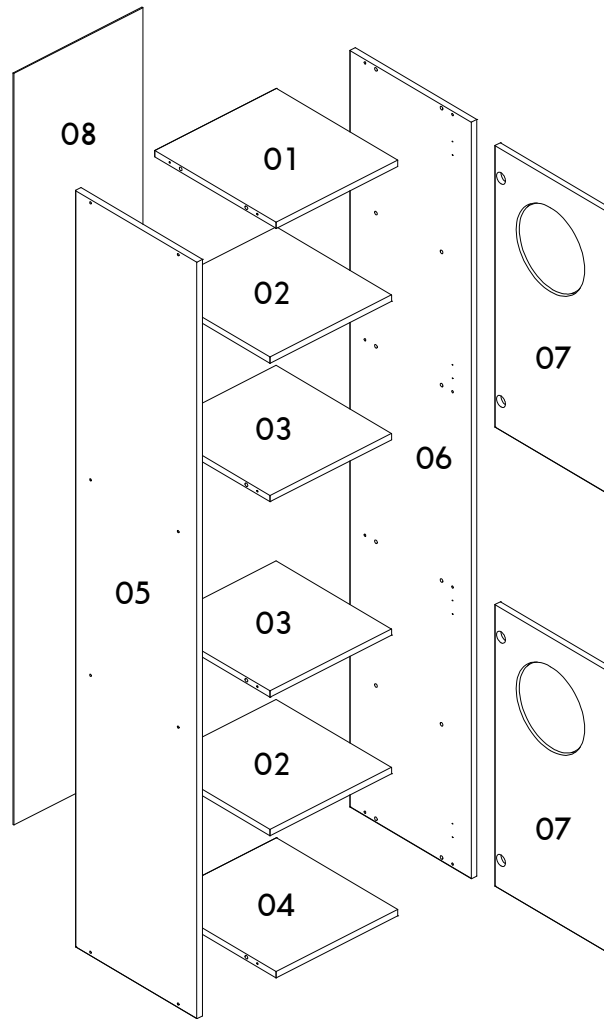

Número / Number / Número	Medidas / Measures / Medidas		Qtd. / Qty. / Qtd.
	cm	inches	
01	33 x 35,5 x 1,5	13" x 14" x 5/8	1
02	33 x 33,4 x 1,5	13" x 13" 1/8 x 5/8	2
03	33 x 33,4 x 1,5	13" x 13" 1/8 x 5/8	2
04	33 x 35,5 x 1,5	13" x 14" x 5/8	1
05	35,5 x 180 x 1,5	14" x 70" 7/8 x 5/8	1
06	35,5 x 180 x 1,5	14" x 70" 7/8 x 5/8	1
07	32,4 x 67 x 1,5	12" 3/4 x 26" 3/8 x 5/8	2
08	178,8 x 35 x 0,3	70" 3/8 x 13" 3/4 x 1/8	1

01

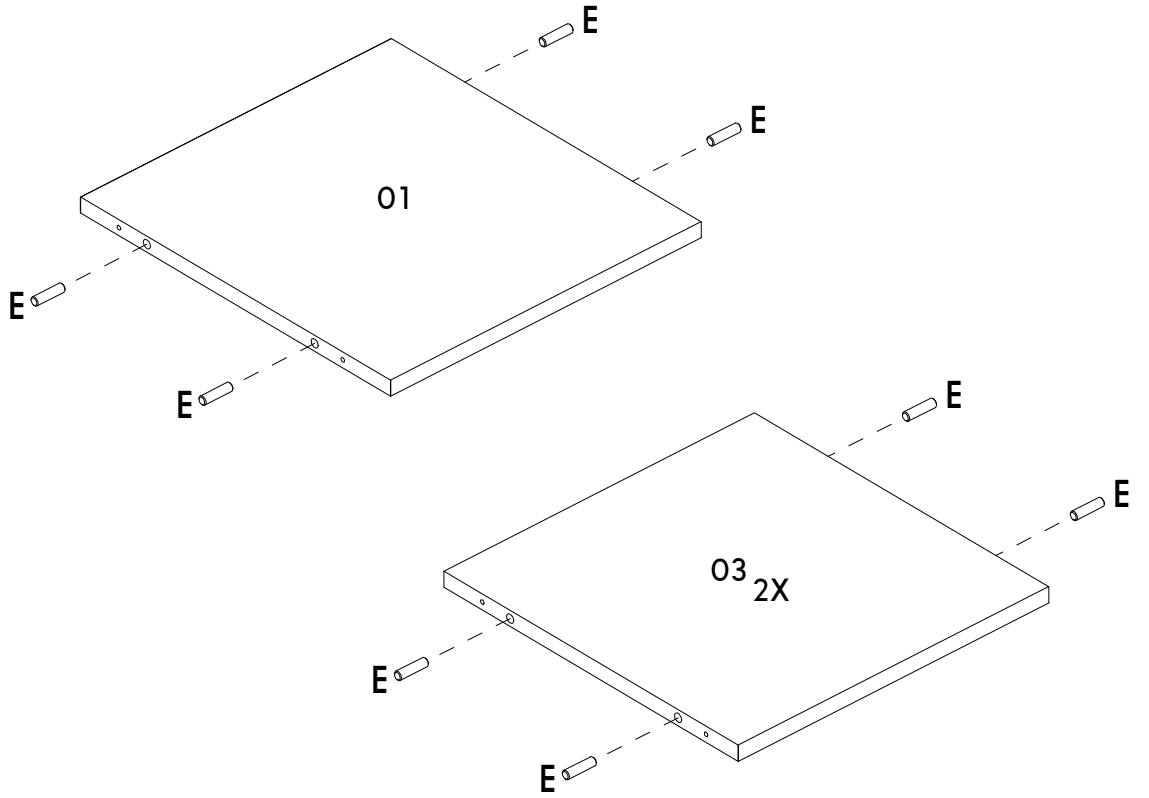
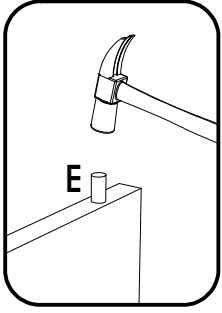

02

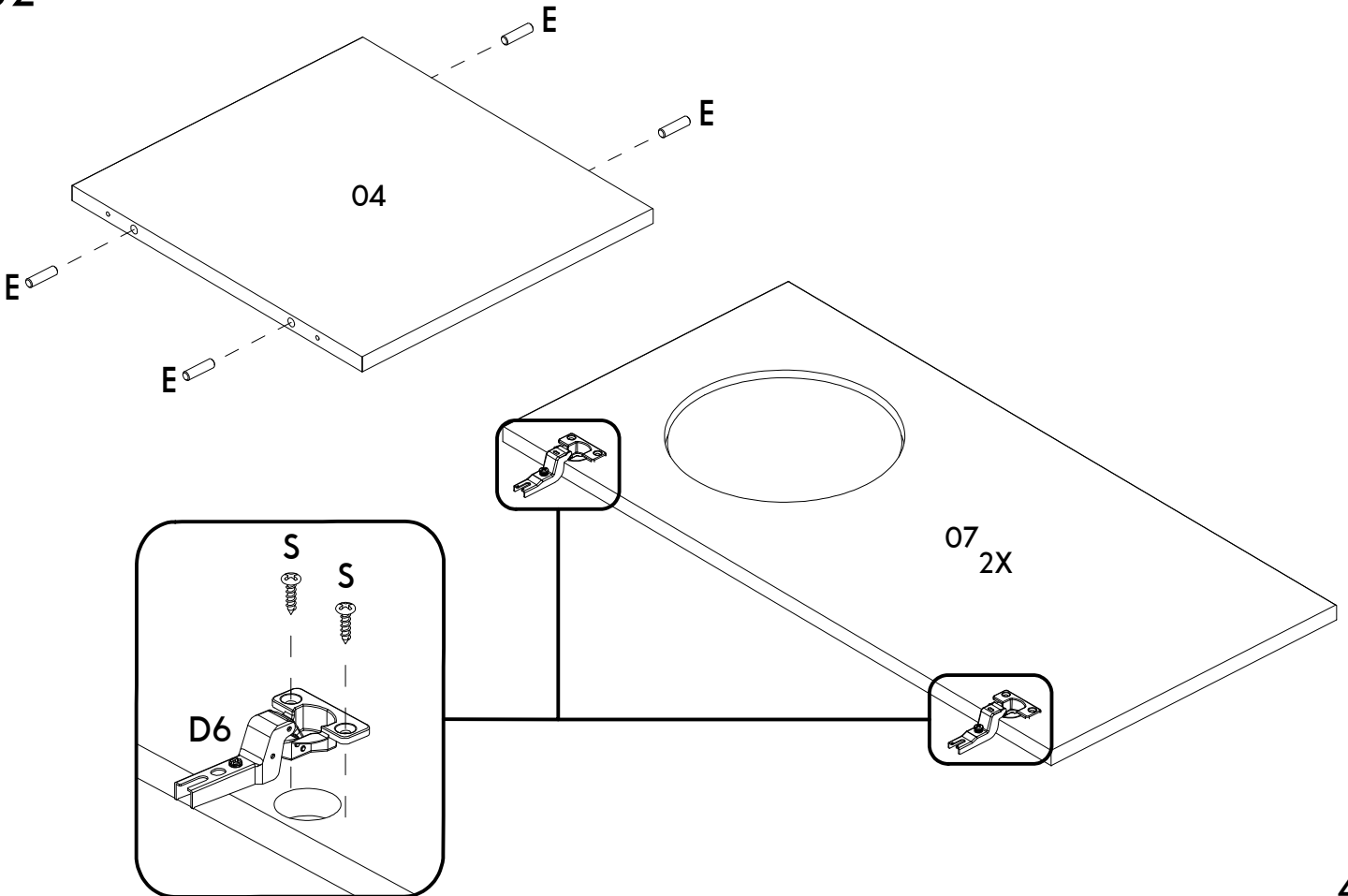

03

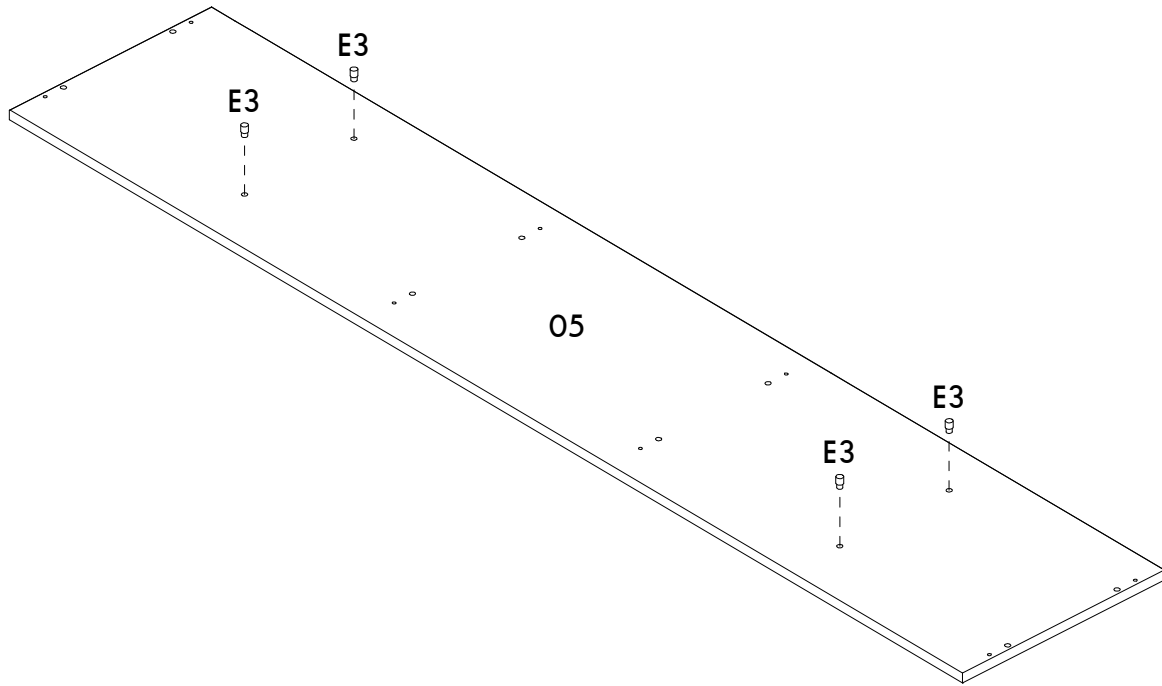

04

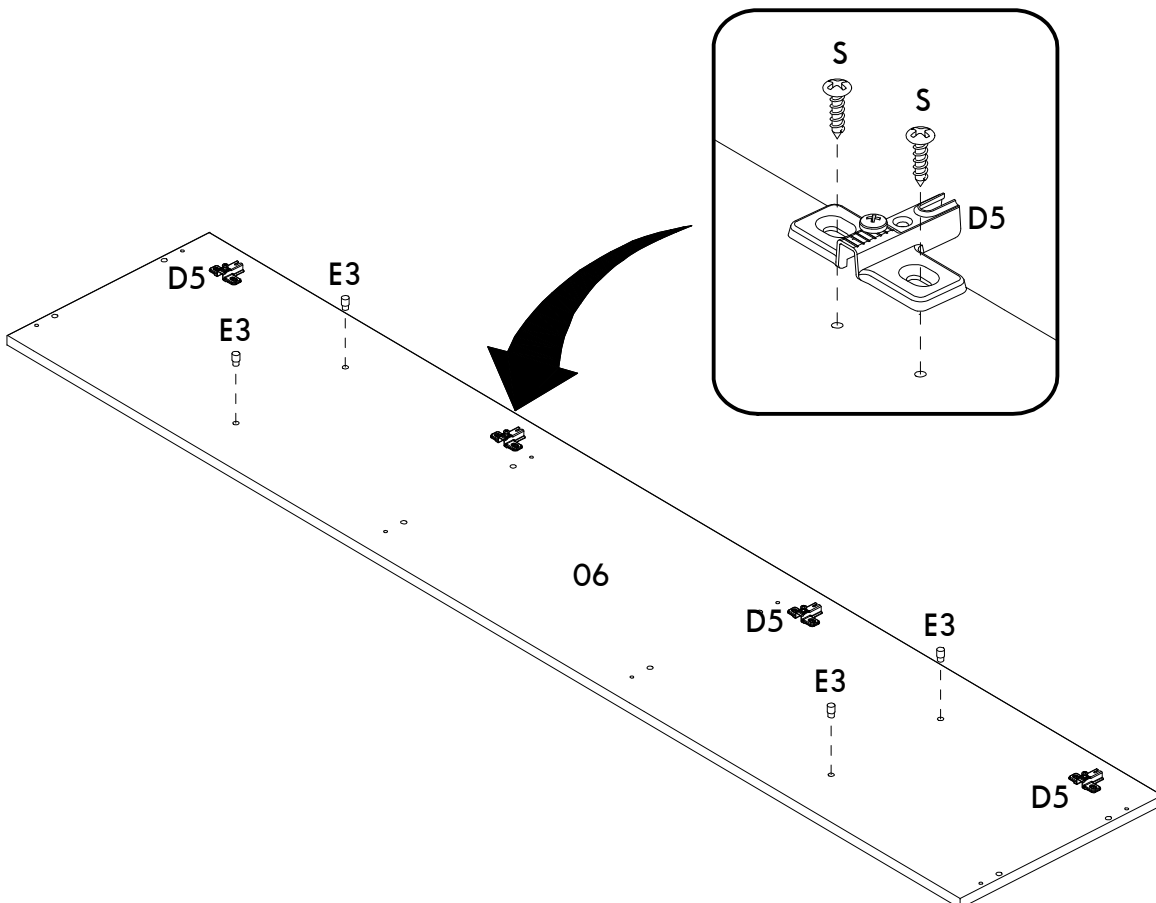

05

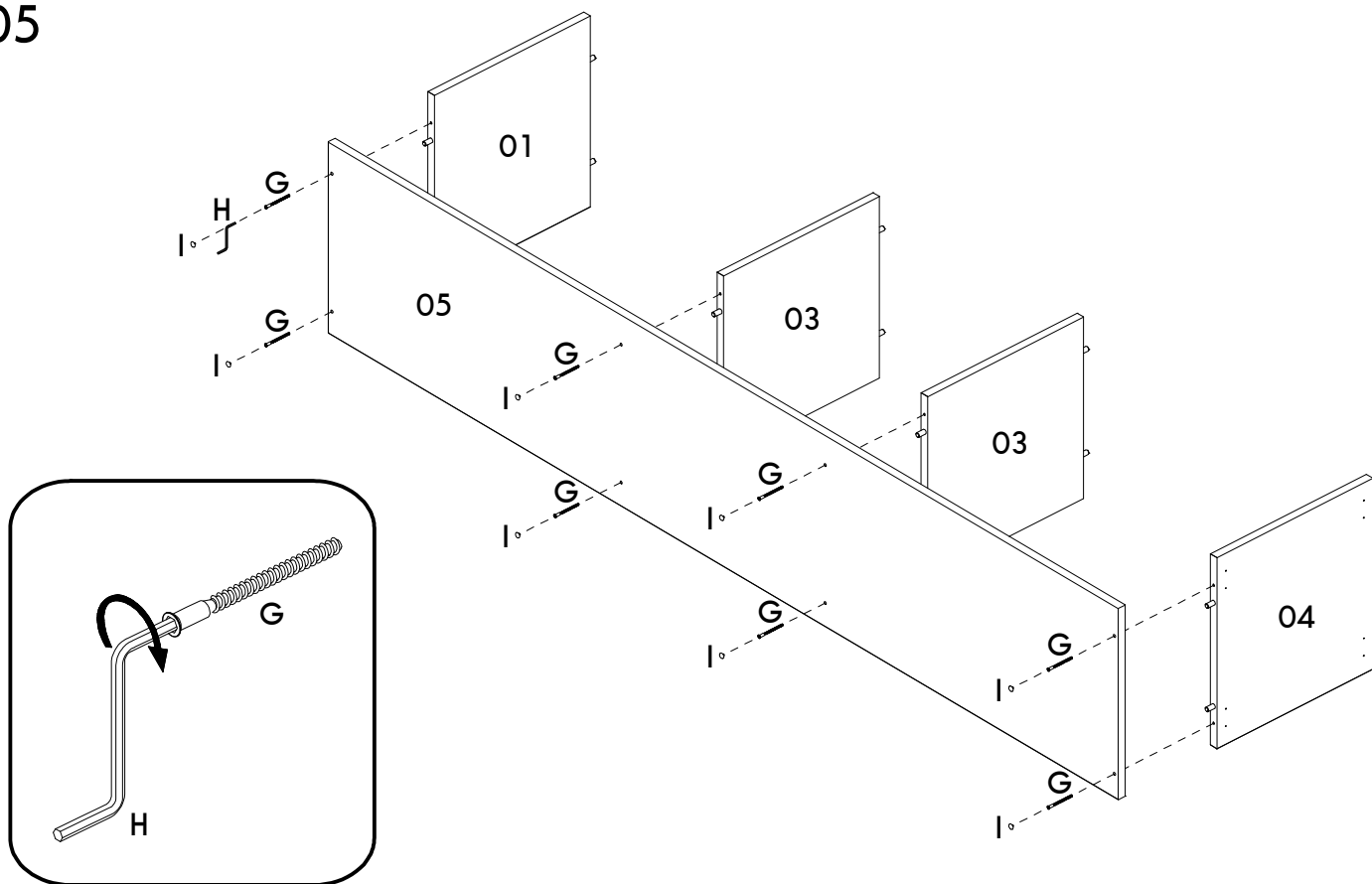

06

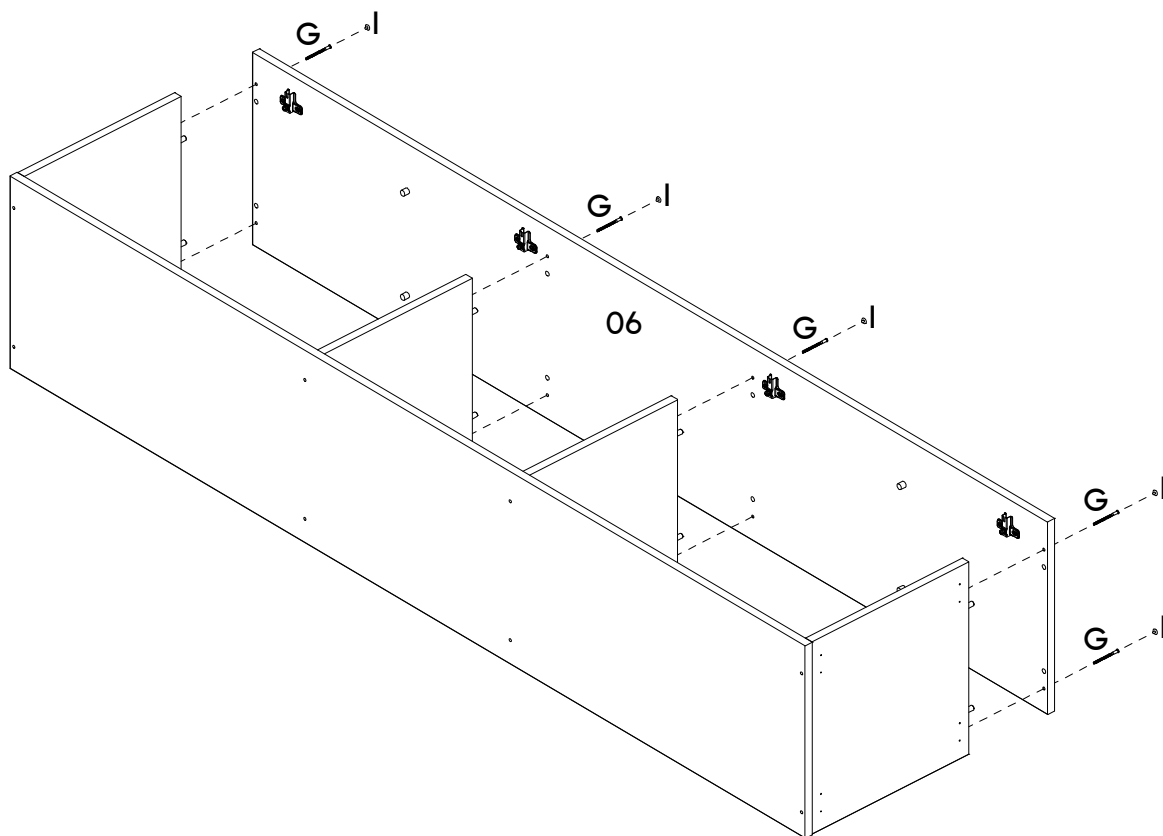

07

PARTE TRASEIRA
REAR
PARTE TRASERA

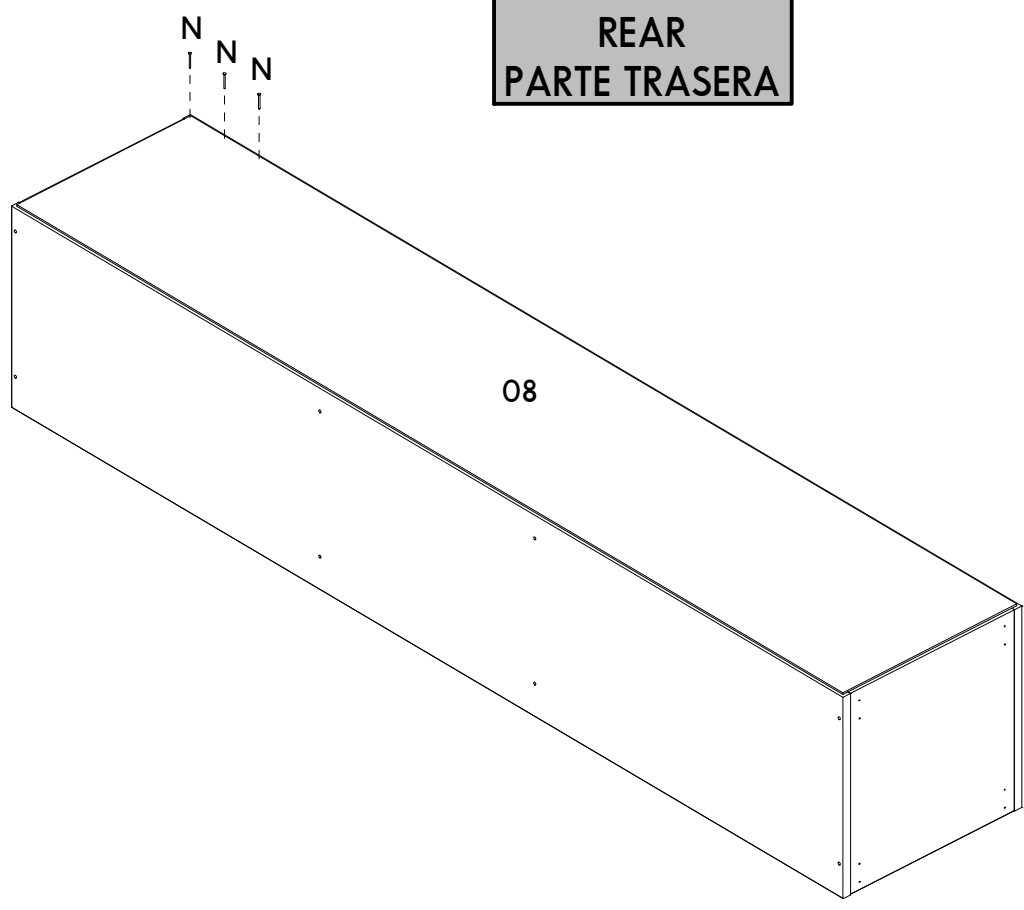

08

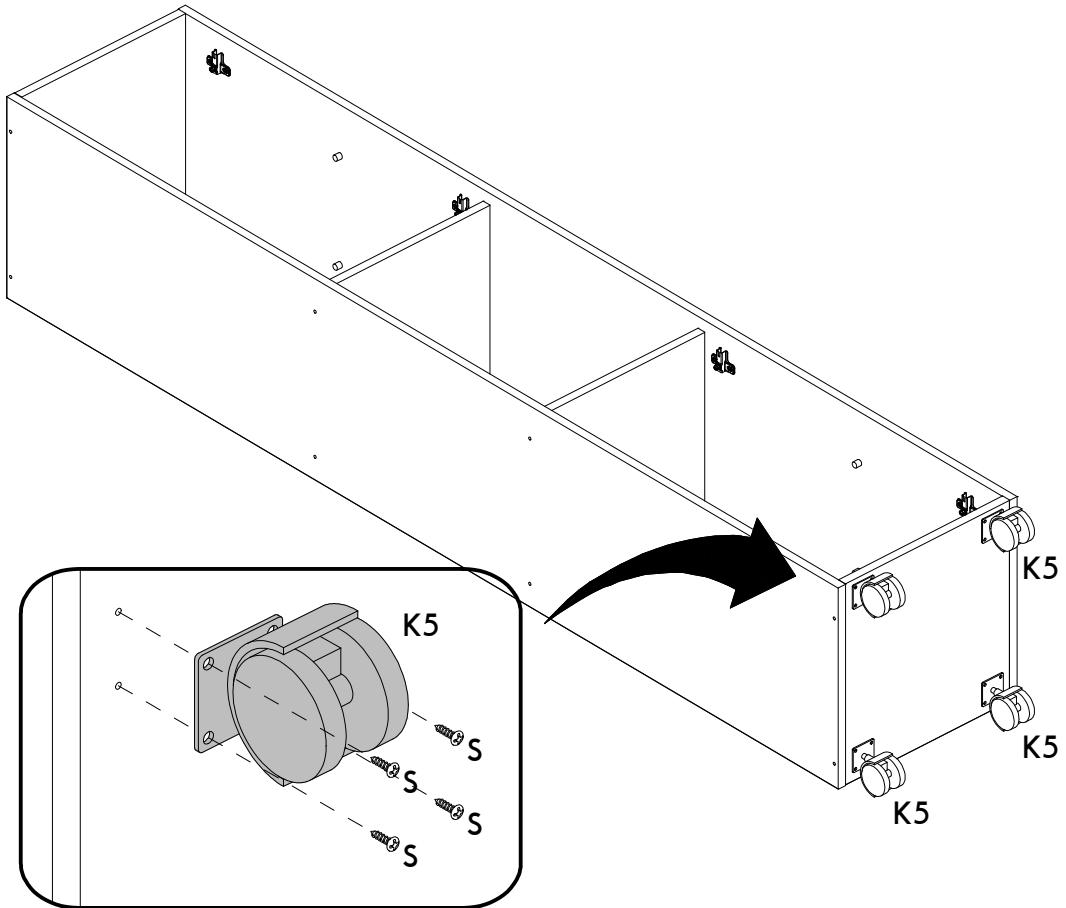

09

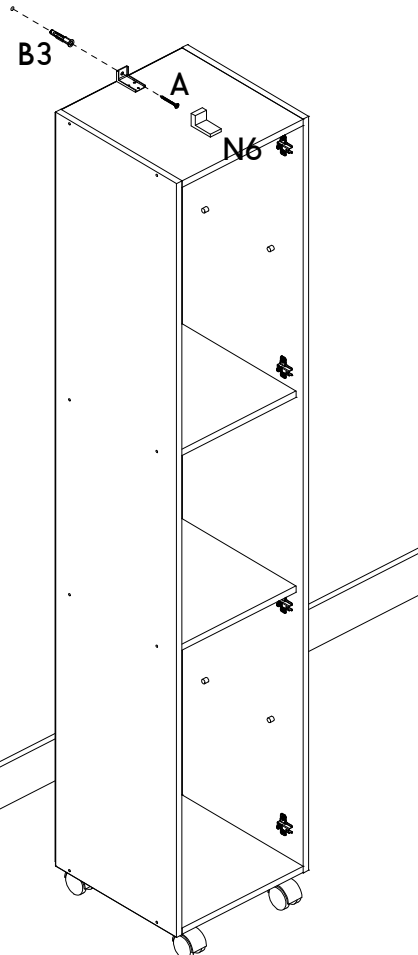
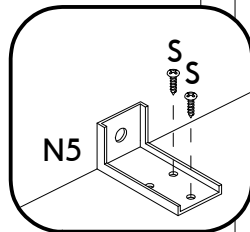

ATENÇÃO! ATTENTION! ¡ATENCIÓN!

CASO POSSUA CRIANÇAS EM SUA RESIDÊNCIA,
ACONSELHAMOS A FIXAÇÃO NA PAREDE.

IF YOU HAVE CHILDREN IN YOUR HOME
WE RECOMMEND INSTALLATION ON THE WALL.

SI USTED TIENE NIÑOS EN SU CASA
LE RECOMENDAMOS LA INSTALACIÓN EN LA PARED.

10

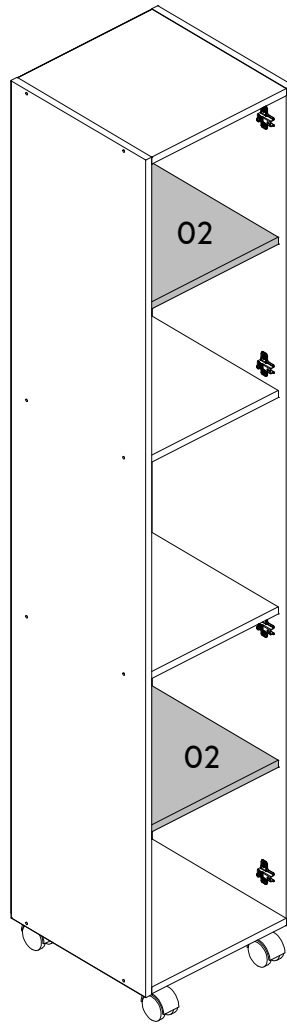

11

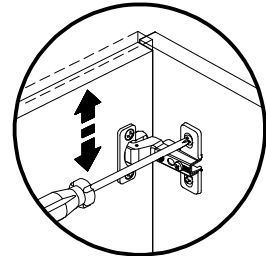
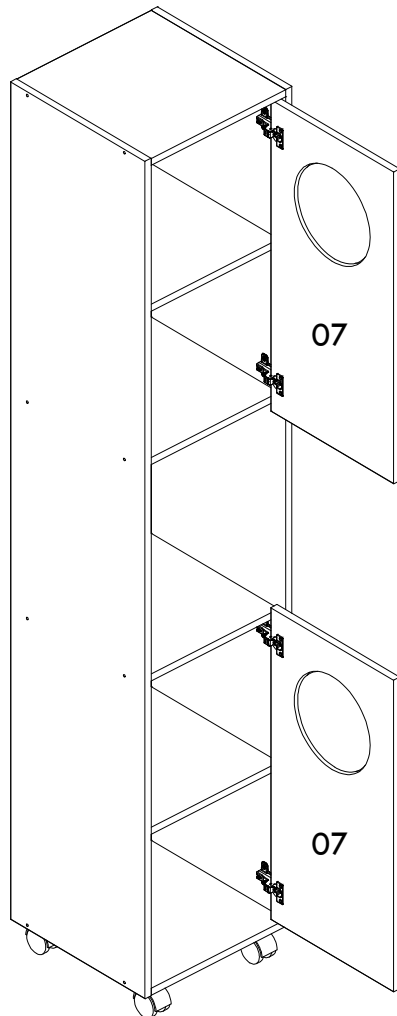

Regulagem Vertical
Ajuste Vertical
Vertical Adjustment

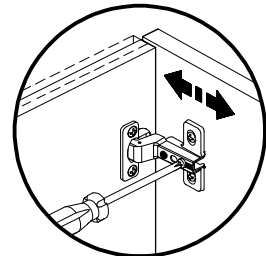

Regulagem Profundidade
Ajuste Profundidad
Depth Adjustment

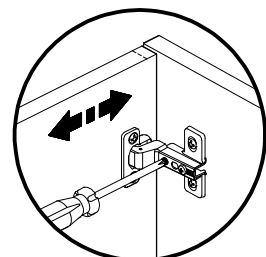

Regulagem Horizontal
Ajuste Horizontal
Horizontal Adjustment

08

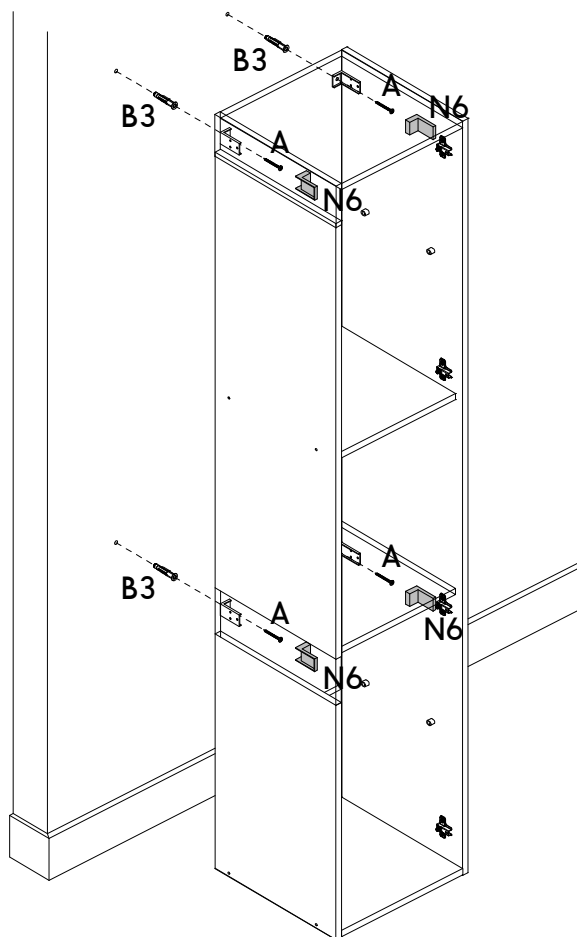
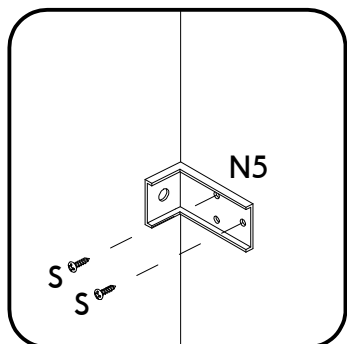

09

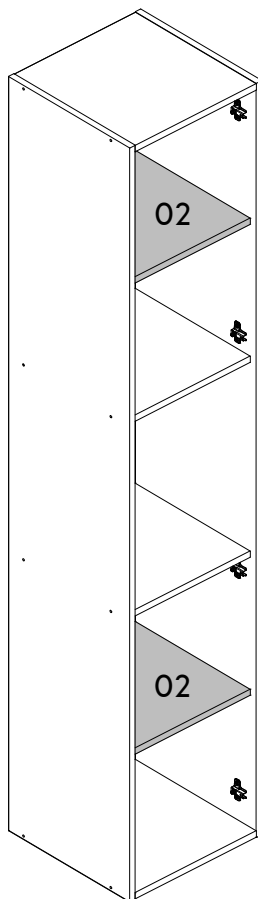

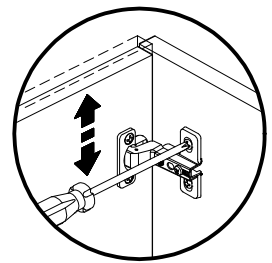
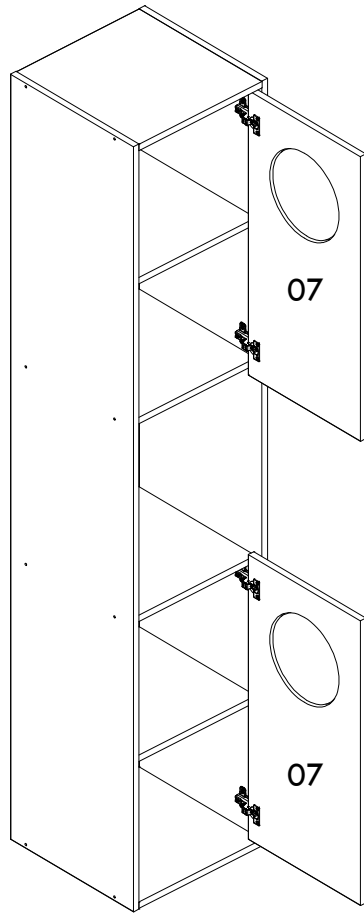

Regulagem Vertical
Ajuste Vertical
Vertical Adjustment

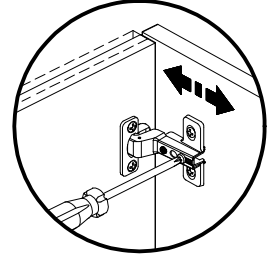

Regulagem Profundidade
Ajuste Profundidad
Depth Adjustment

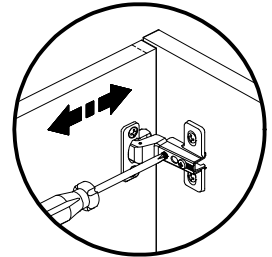

Regulagem Horizontal
Ajuste Horizontal
Horizontal Adjustment

PESO MÁXIMO RECOMENDADO SENDO ESTE DISTRIBUÍDO UNIFORMEMENTE
MAXIMUM RECOMMENDED WEIGHT BEING THIS EVENLY DISTRIBUTED / PESO MÁXIMO RECOMENDADO SIENDO ESTE UNIFORMEMENTE DISTRIBUIDO

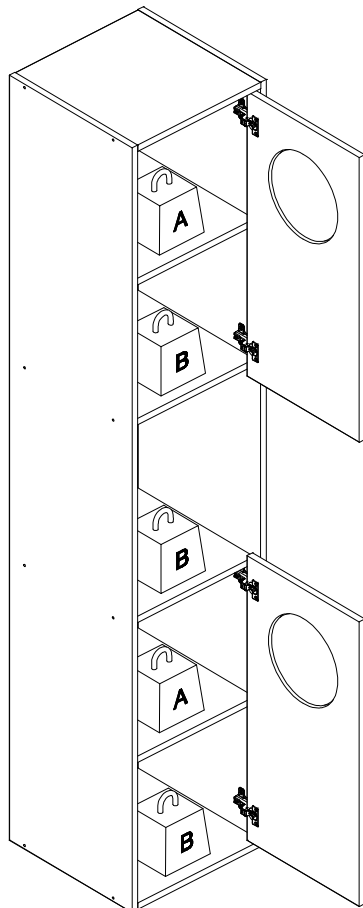

	KG	LB
A	5	11
B	10	22