

MANUAL DE MONTAGEM

ASSEMBLY INSTRUCTIONS / INSTRUCCIONES DE ARMADO

ESTANTE MACAU
MACAU bookcase
Estantería MACAU

Código **180643** | Revisão 00

Português
English
Español

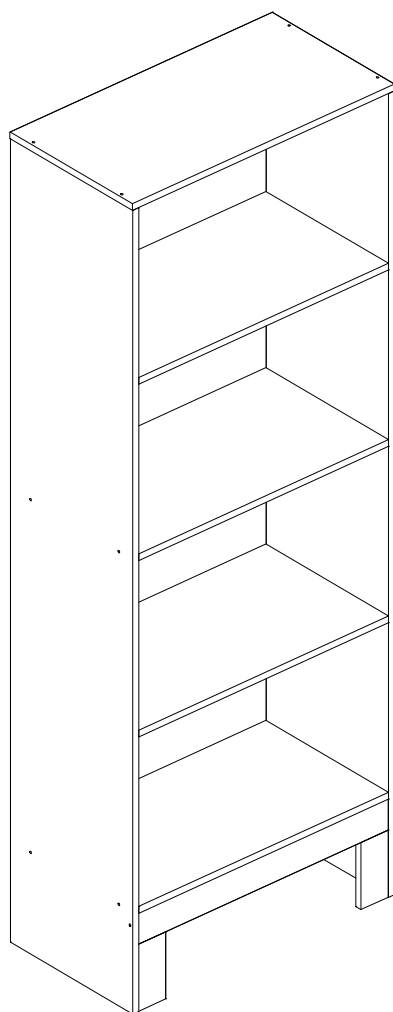

VOCÊ VAI PRECISAR DE / YOU WILL NEED / USTED NECESITARÁ

Ferramentas não fornecidas / Tools not supplied / Herramientas no incluidas

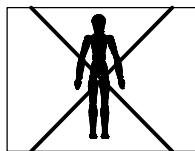

1 Pessoa
1 Person
1 Persona

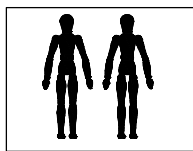

2 Pessoas
2 People
2 Personas

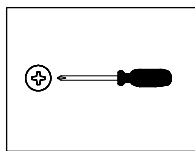

Chave Phillips
Screwdriver Phillips
Destornillador cruz

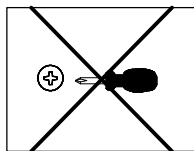

Chave Phillips Menor
Small screwdriver Phillips
Destornillador cruz menor

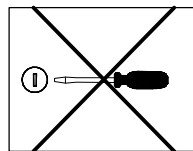

Chave fenda
Screwdriver slotted
Destornillador plano

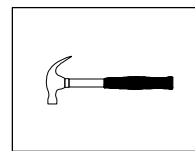

Martelo
Hammer
Martillo

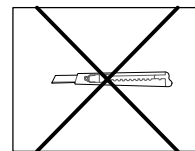

Estilete
Stylet
Estilete

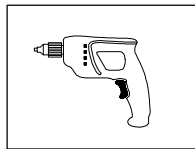

Furadeira
Drill machine
Taladro

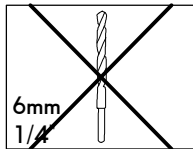

Broca
Drill bit
Taladro

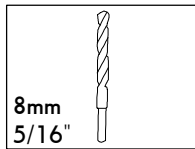

Broca
Drill bit
Taladro

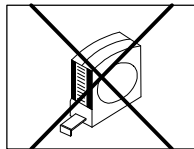

Trena
Measuring tape
Cinta de medición

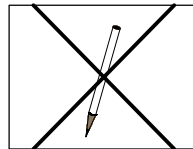









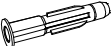

Lápis
Pencil
Lápiz

NOTAS: A separação dos acessórios antes de iniciar a montagem facilitará a mesma. Em caso de dúvida no tamanho dos parafusos e cavilhas, utilize a régua ao final da página 2.

NOTES: The separation of the accessories before you start the assembly will facilitate the same. In case of doubt on the size of the screws and bolts, use the ruler to bottom of page 2.

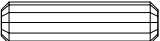
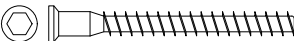
NOTAS: La separación de los accesorios antes de comenzar el armado facilitará el mismo. En caso de duda sobre el tamaño de los tornillos y taquetes, utilice la regla al pie de página 2.

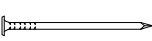
IDENTIFICAÇÃO DOS ACESSÓRIOS/ IDENTIFICATION OF ACCESSORIES/ IDENTIFICACIÓN DE ACCESORIOS

A		Parafuso flangeado / Flanged head screw / Tornillo de cabeza flangeada	5,0x60 mm	1
A2		Sapata redonda / Small plastic foot / Pie plástico	14 mm	4
A4		Cantoneira de metal / Metallic bracket / Suporte de metal	22x22 mm	1
B3		Bucha expansiva / Bushing / Tapón	8x50 mm	1
B5		Cantoneira de metal / Metallic angle plates / Suporte de metal	46 mm	2
B6		Junção de tampos / Junction of tops / Unión de tapas	40x40 mm	2
B7		Suporte de metal / Metallic bracket / Suporte de metal	-	1
C1		Garra de metal / Metal claw / Garra metal	-	9
E		Cavilha / Wooden dowel / Taquete	8x30 mm	22
G		Parafuso estrutural / Structural screw / Tornillo estrutural	5,0x50 mm	14
H		Chave allen / Allen key / Liave allen	3 mm	1
I		Tampa parafuso estrutural / Structural screw cover / Tapa tornillo estrutural	-	10
N		Prego / Nail / Clavo	10 x10	63
S		Parafuso panela / Pan head screw / Tornillo de pan	3,5x14 mm	20



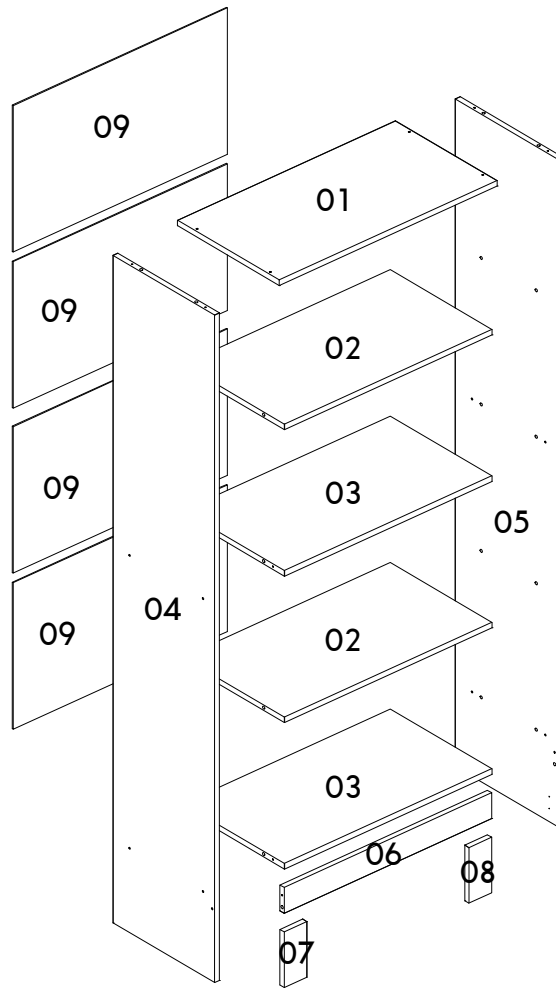

Número / Number / Número	Medidas / Measures / Medidas		Qtd. / Qty. / Qtd.
	cm	inches	
01	67 x 35,5 x 1,5	26" 3/8 x 14" x 5/8	1
02	63,8 x 35,5 x 1,5	25" 1/8 x 14" x 5/8	2
03	63,8 x 35,5 x 1,5	25" 1/8 x 14" x 5/8	2
04	180 x 35,5 x 1,5	70" 7/8 x 14" x 5/8	1
05	180 x 35,5 x 1,5	70" 7/8 x 14" x 5/8	1
07	7 x 15 x 1,5	2" 3/4 x 5" 7/8 x 5/8	1
08	7 x 15 x 1,5	2" 3/4 x 5" 7/8 x 5/8	1
09	65,8 x 39,5 x 0,3	25" 7/8 x 15" 1/2 x 1/8	4

01

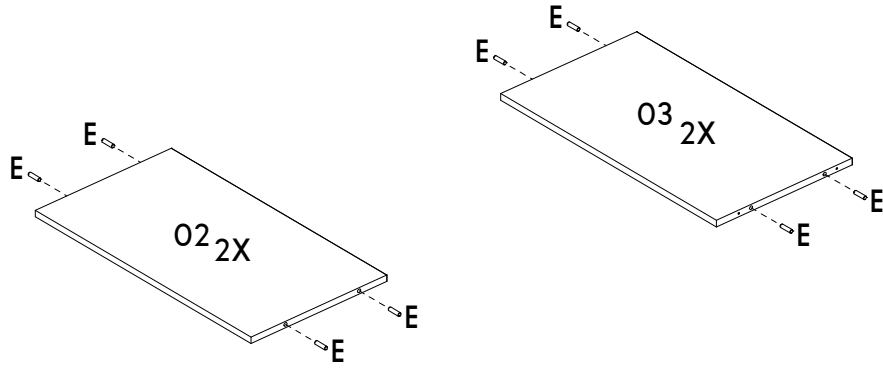
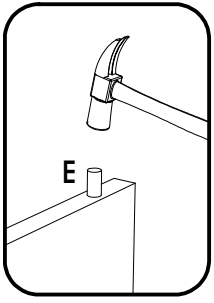

02

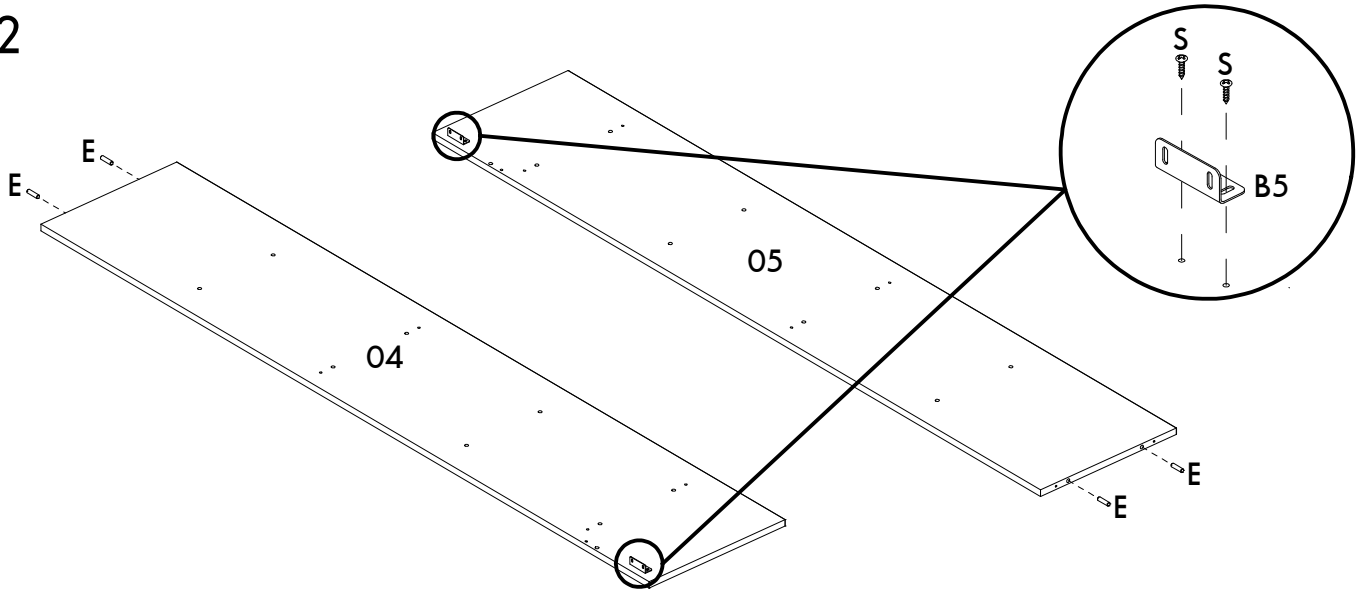

03

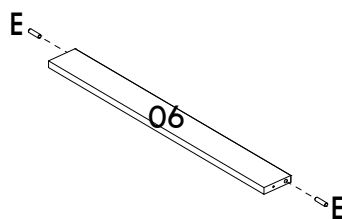

04

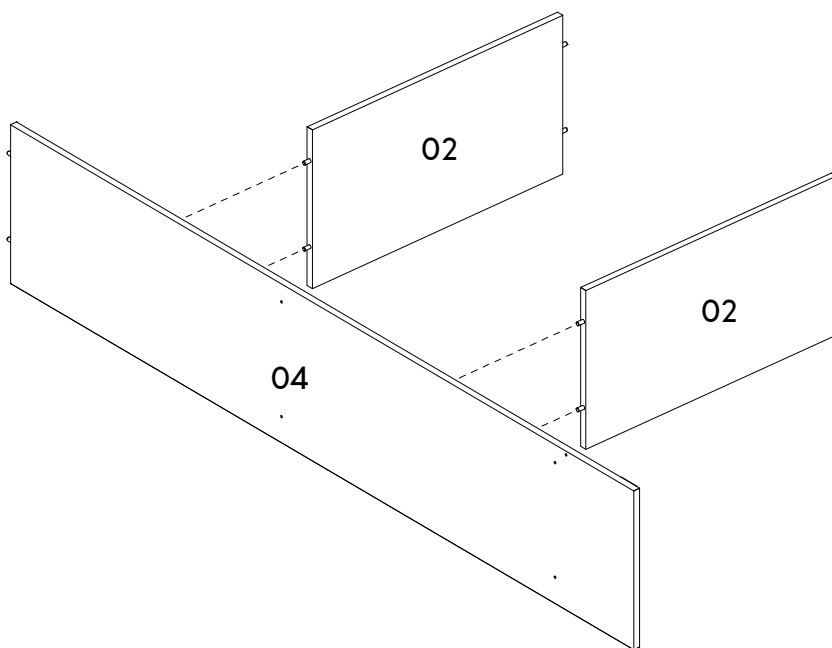

05

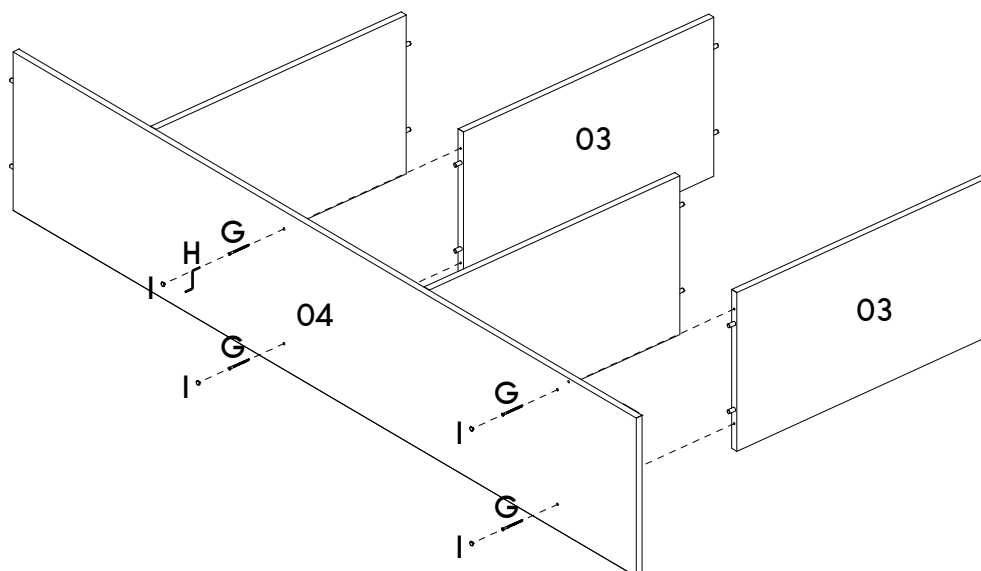
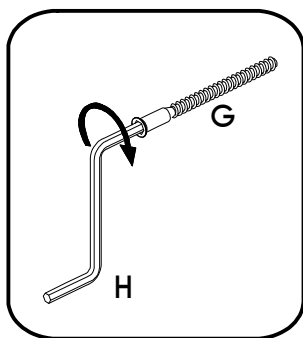

06

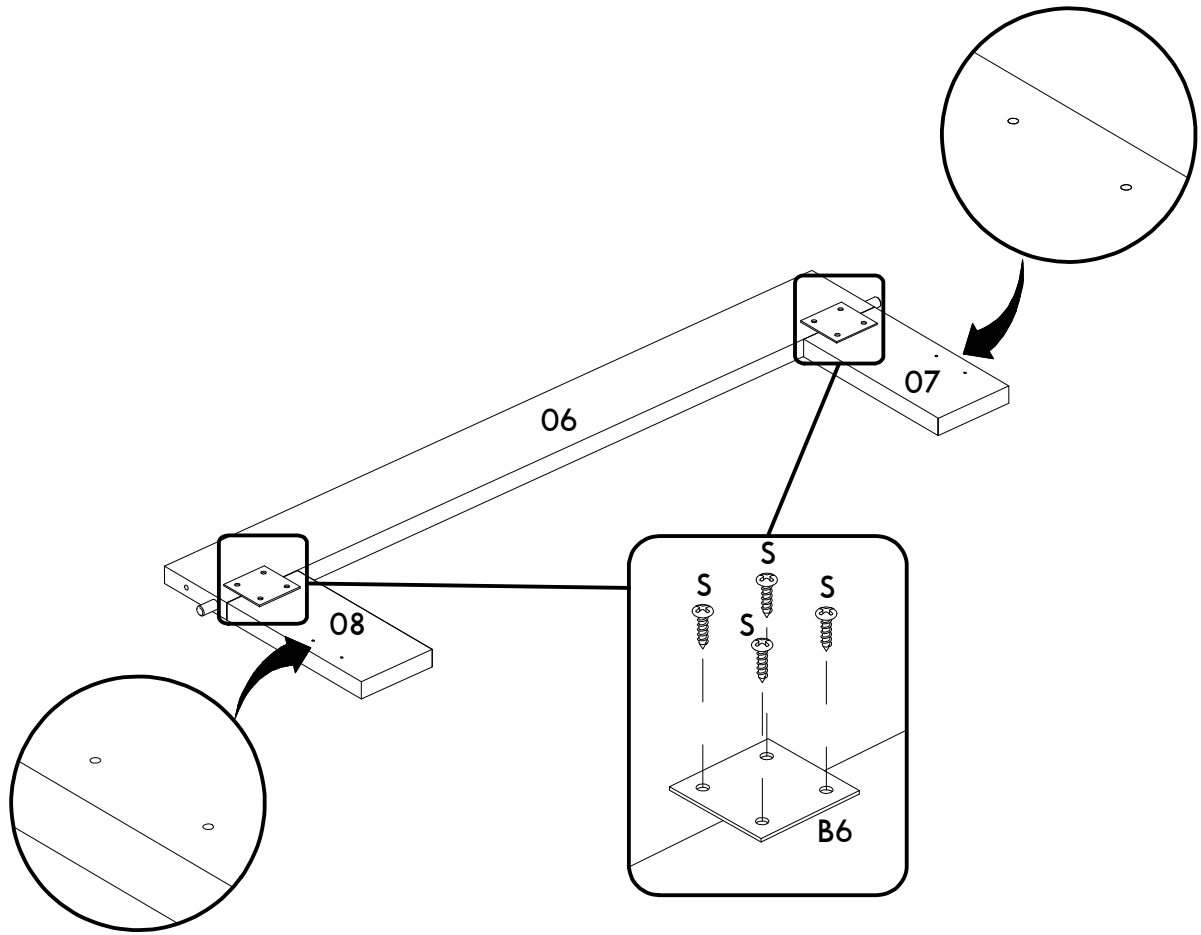

07

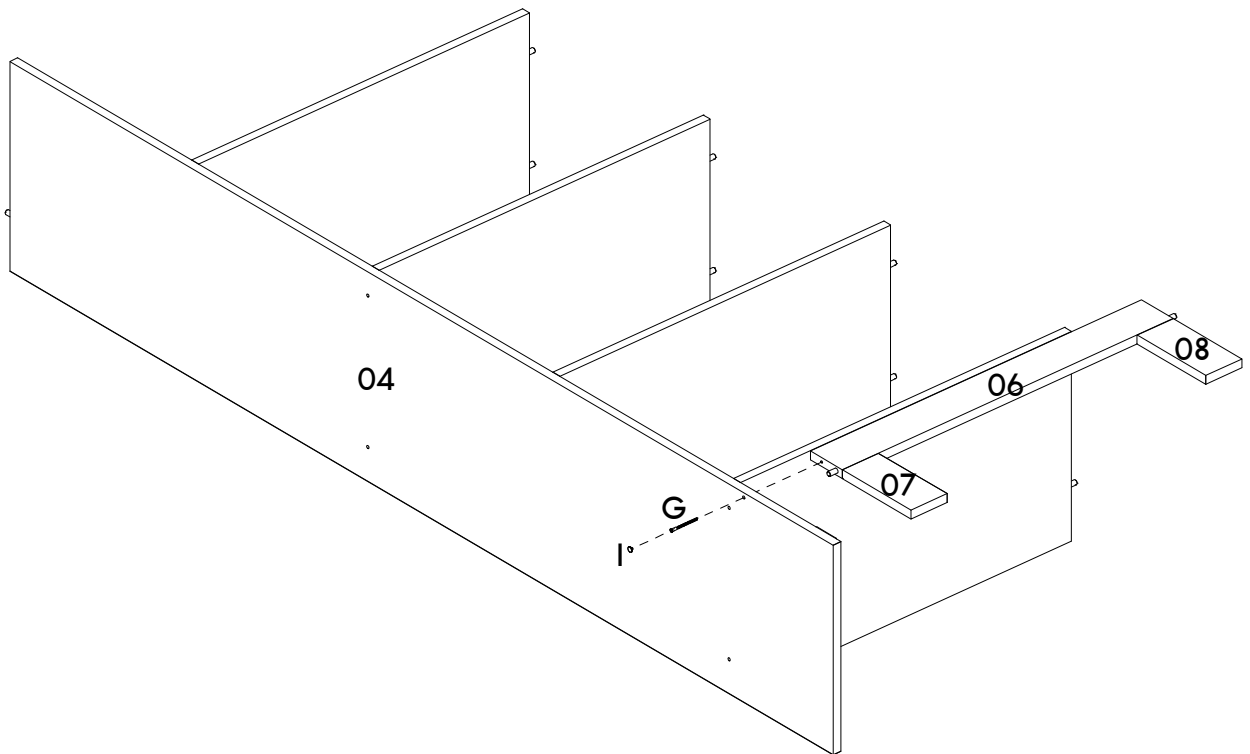

08

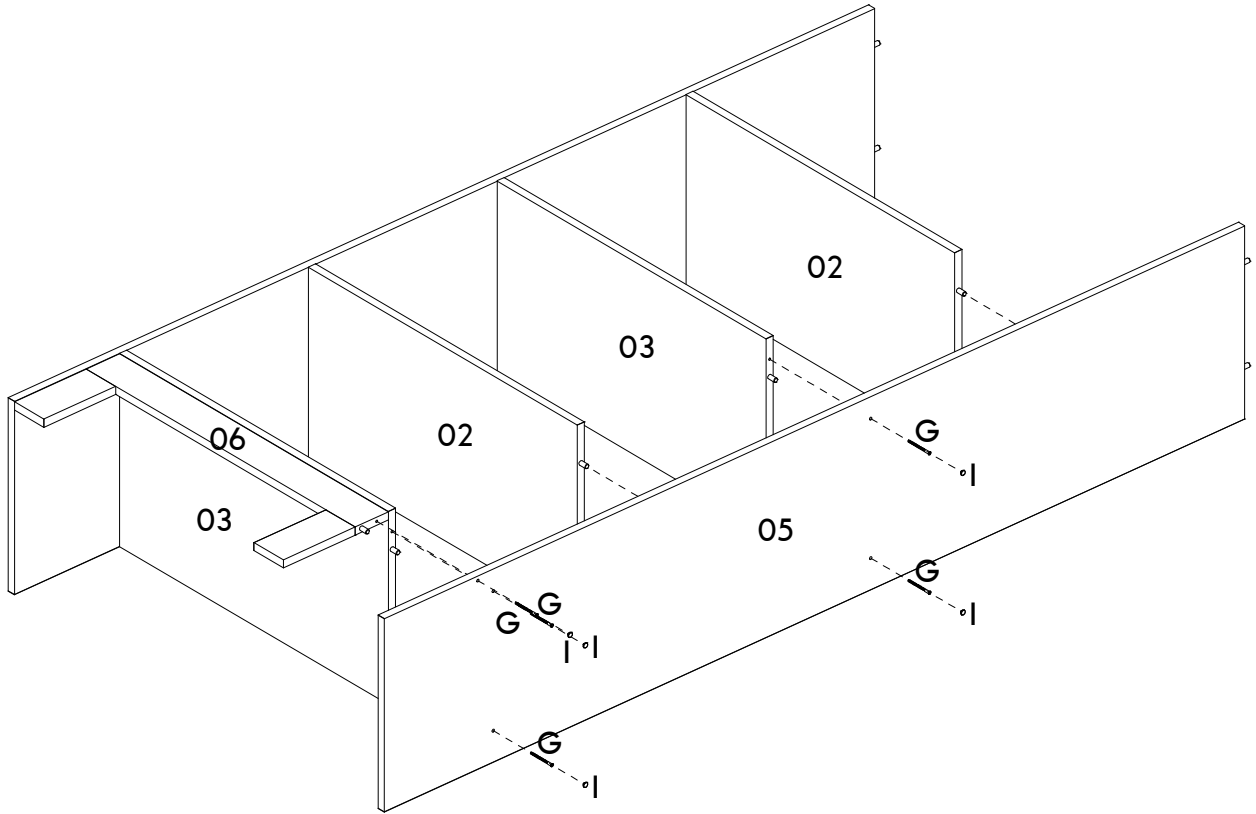

09

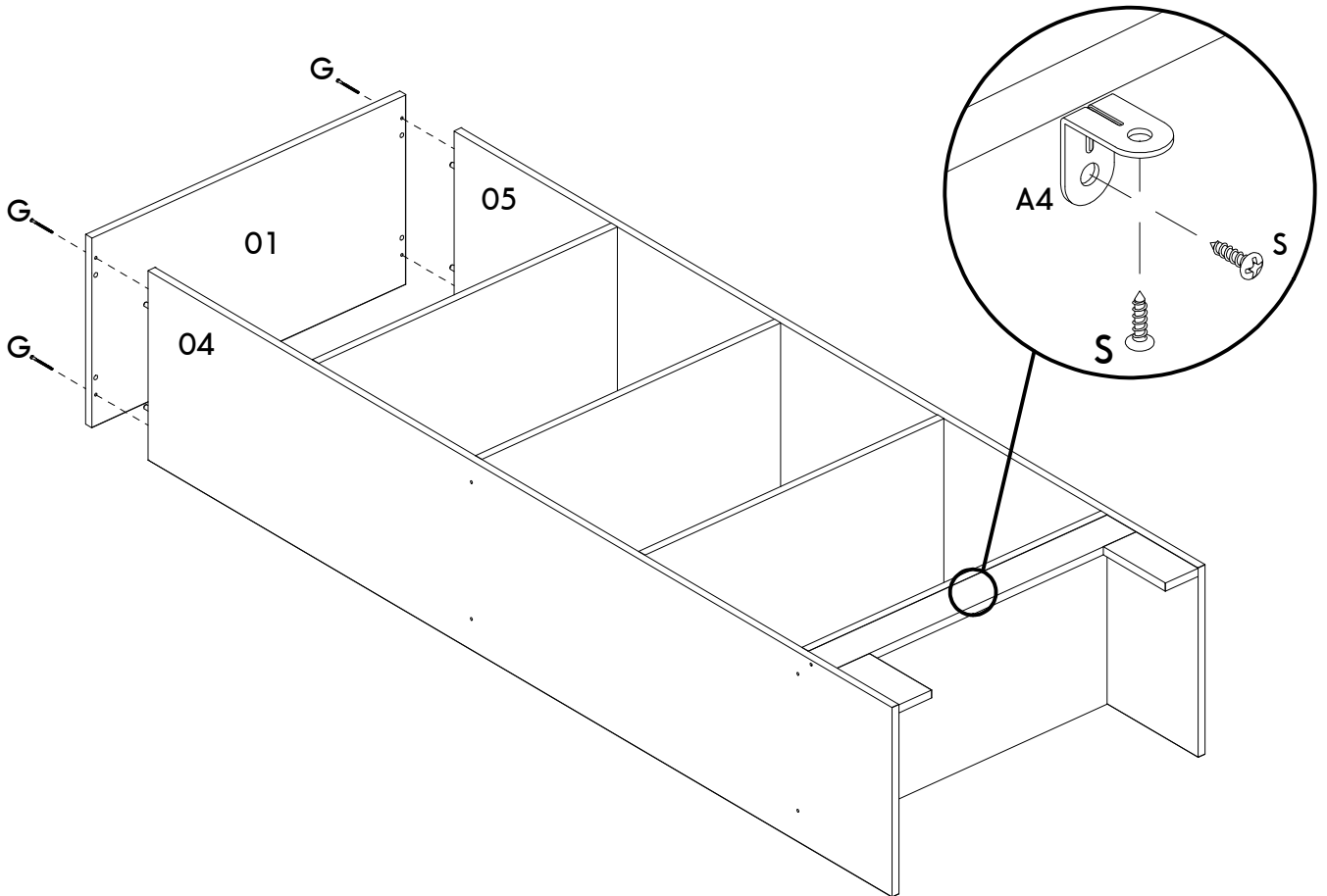

10

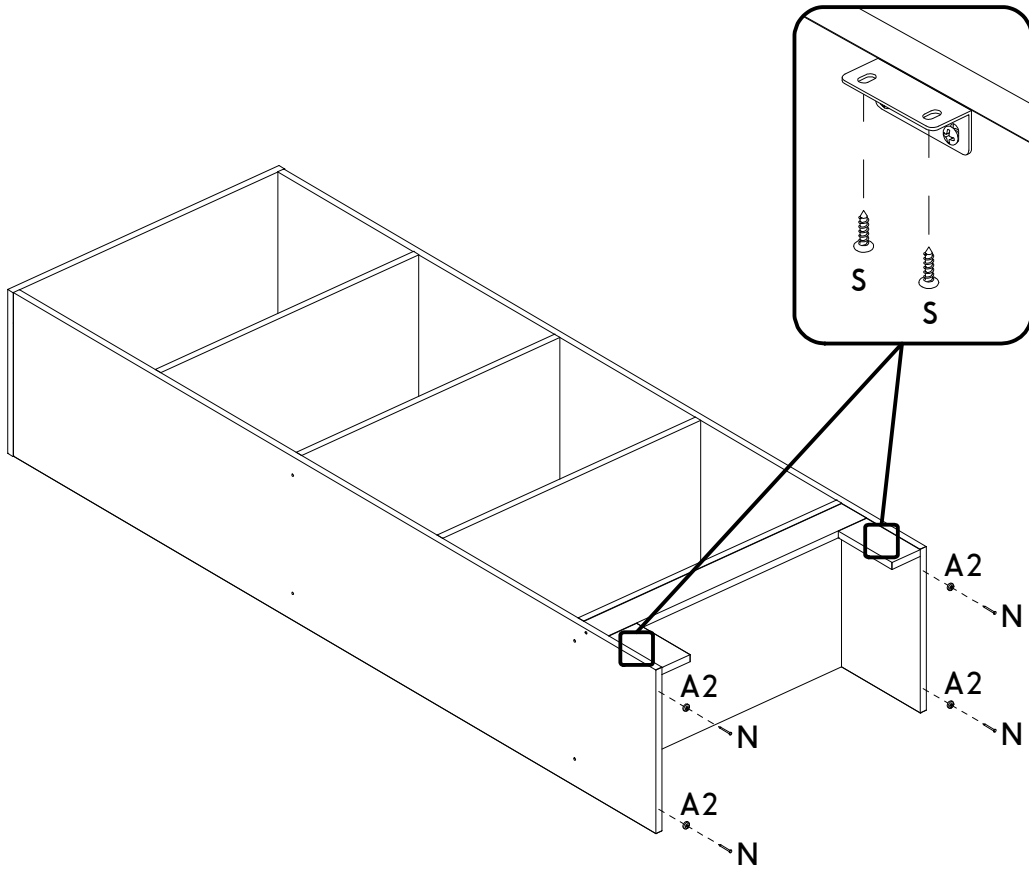

11

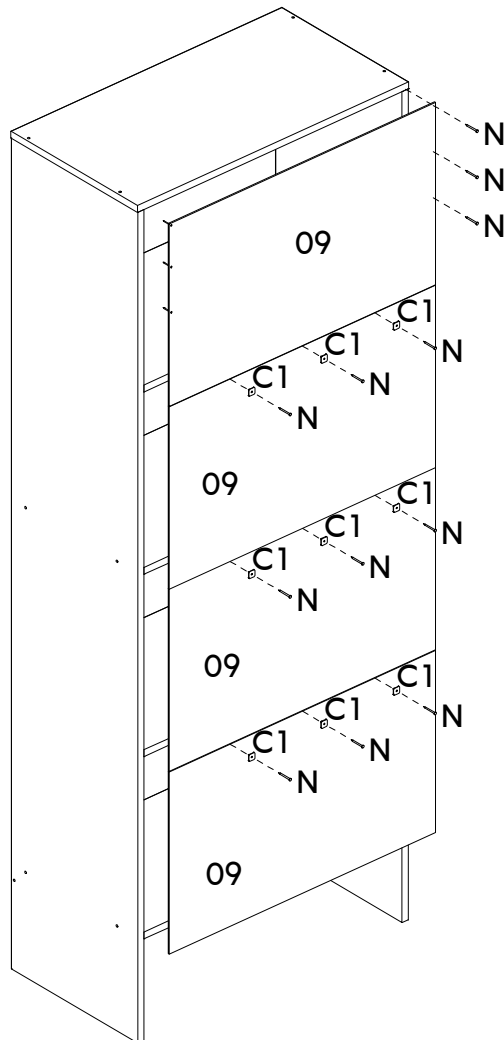

12

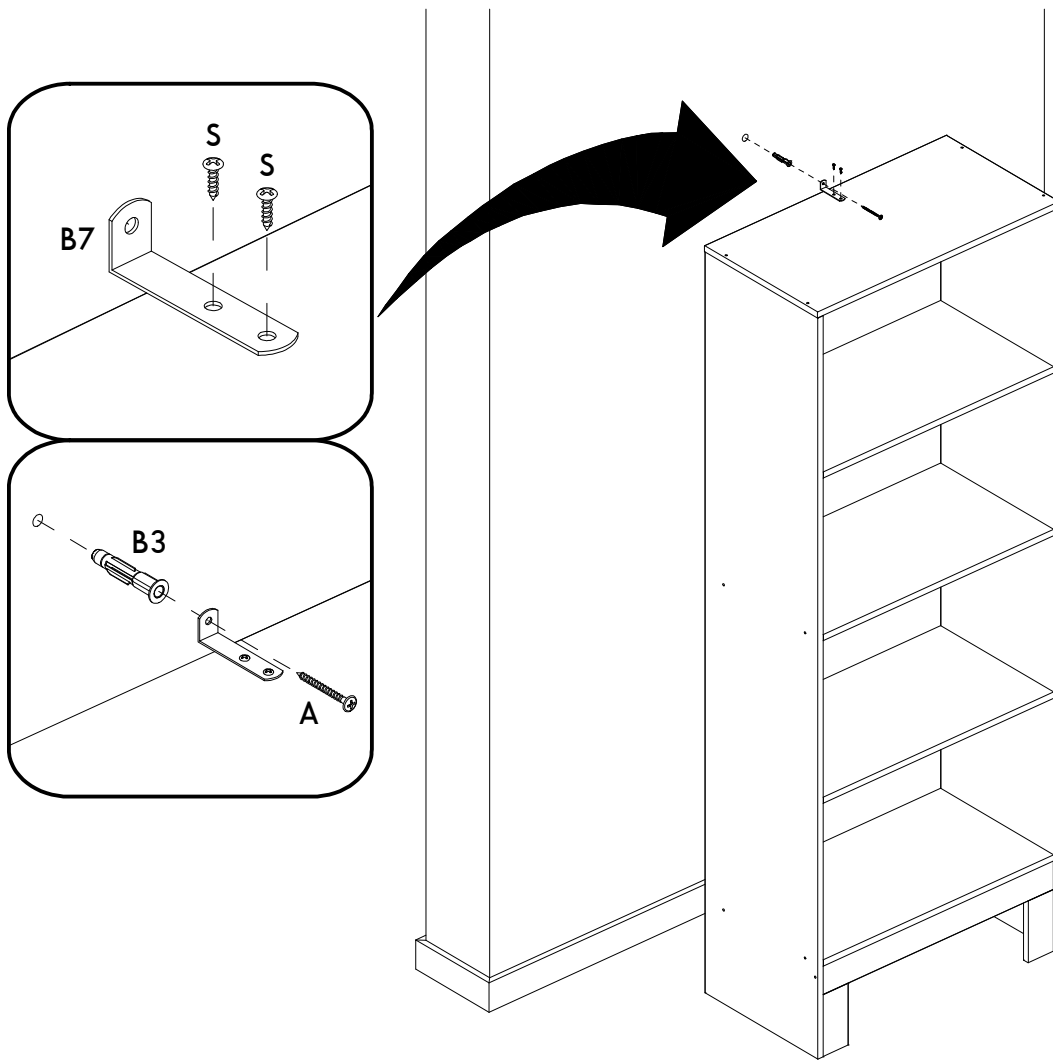

PESO MÁXIMO RECOMENDADO SENDO ESTE DISTRIBUIDO UNIFORMEMENTE
MAXIMUM RECOMMENDED WEIGHT BEING THIS EVENLY DISTRIBUTED / PESO MÁXIMO RECOMENDADO SIENDO ESTE UNIFORMEMENTE DISTRIBUIDO

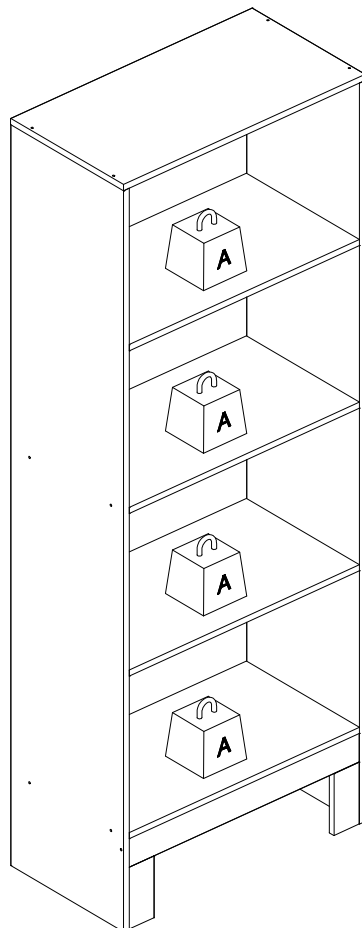

	KG	LB
A	10	22