

MANUAL DE MONTAGEM  
Assembly instructions / Instrucciones de armado

MÓDULO TORRE QUENTE FLORIPA 2160 x 705 x 510

Floripa ovens tower 85" 1/16 x 27" 3/4 x 20" 1/16  
Torre de Hornos Floripa 2160 x 705 x 510

Código 170550 | Revisão 01

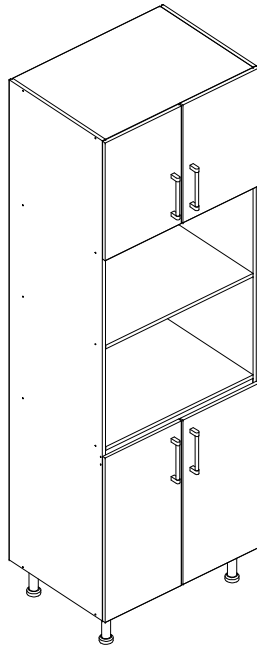

PESO MÁXIMO SUPORTADO PELAS PEÇAS, SENDO ESTE DISTRIBUÍDO UNIFORMEMENTE.

Maximum weight supported by parts, being this evenly distributed.  
Peso máximo soportado por las partes, siendo esta distribuido uniformemente.

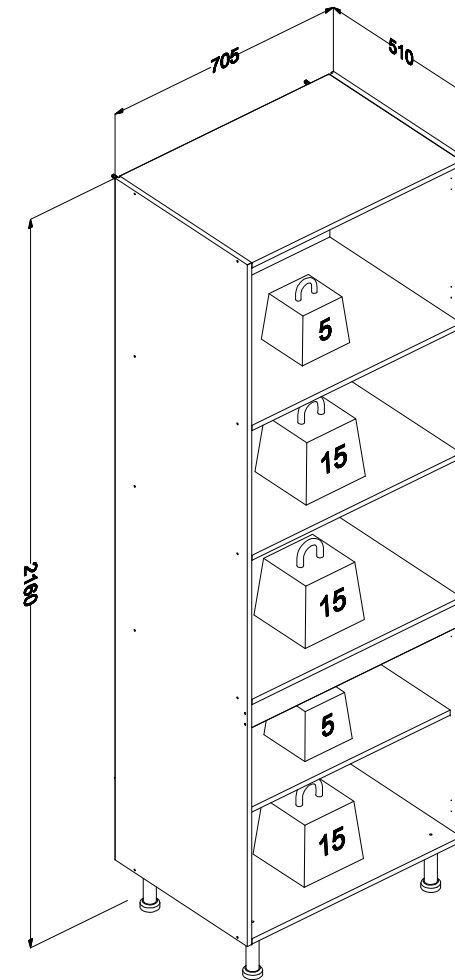

Você vai precisar de/ You will need / Usted necesitará

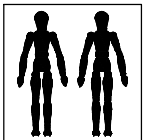

2 Pessoas  
2 People  
2 Personas

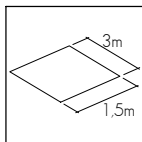

Espaço recomendado para montagem  
Recommended space for assemble  
Espacio recomendado para el armado

Ferramentas não inclusas  
Tools not included / Herramientas no incluidas

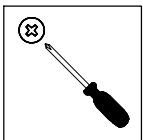

Chave Phillips  
Screwdriver Phillips  
Destornillador cruz

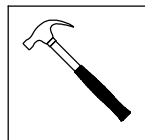

Martelo  
Hammer  
Martillo

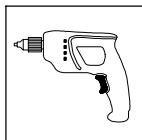

Furadeira  
Drill machine  
Taladro

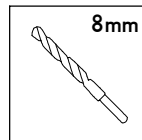

Broca  
Drill bit  
Taladro







\* PESO EM KG/ Weight in Kg/ Peso en Kg  
DIMENSÕES EM MM/ Dimensions in mm/ Dimensiones en mm

**IDENTIFICAÇÃO DOS ACESSÓRIOS/ IDENTIFICATION OF ACCESSORIES/ IDENTIFICACIÓN DE ACCESORIOS**

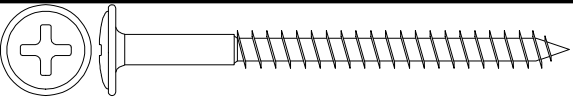
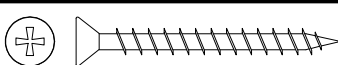
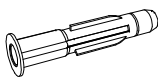
**NOTAS:** A separação dos acessórios antes de iniciar a montagem facilitará a mesma. Os parafusos e cavilhas estão na escala real. Em caso de dúvida na identificação, coloque o acessório sobre a imagem.

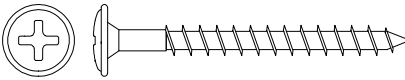
**NOTES:** The separation of the accessories before you start the assembly will facilitate the same. The screws and dowels are in real scale. In case of doubts about the identification, place the accessory on the image.

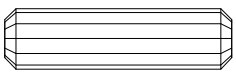
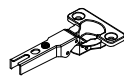
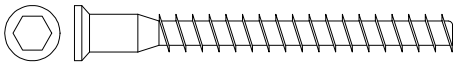
**NOTAS:** La separación de los accesorios antes de comenzar el armado facilitará el mismo. Los tornillos y taquetes son en escala real. En caso de dudas sobre la identificación, coloque el accesorio en la imagen.

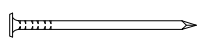
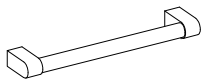
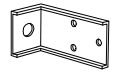
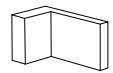
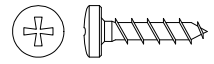
A		<b>Parafuso flangeado</b> Flanged head screw Tornillo de cabeza flangeada	5,0x60 mm	<b>02</b>	T8		<b>Parafuso chato</b> Flat head screw Tornillo de cabeza plana	3,5x35 mm	<b>08</b>
B3		<b>Bucha expansiva</b> Bushing Tapón	8x50 mm	<b>02</b>	U3		<b>Pé Rovi</b> Foot Pie	-	<b>04</b>
C1		<b>Garra de metal</b> Metal claw Garra metal	-	<b>03</b>					
D4		<b>Parafuso flangeado</b> Flanged head screw Tornillo de cabeza flangeada	4,0x40 mm	<b>04</b>					
D5		<b>Calço dobradiça</b> Hinge shim Bisagra de calce	-	<b>08</b>					
E		<b>Cavilha</b> Wooden Dowel Taquete	8x30 mm	<b>24</b>					
F9		<b>Dobradiça reta</b> Metal hinge straight Bisagra recta	26mm	<b>08</b>					
G		<b>Parafuso estrutural</b> Structural screw Tornillo estructural	5,0x50 mm	<b>24</b>					
H		<b>Chave allen</b> Allen key Llave Allen	-	<b>02</b>					
I		<b>Tampa parafuso estrutural</b> Structural screw cover Tapa tornillo estructural	-	<b>24</b>					
N		<b>Prego</b> Nail Clavo	10 x10	<b>49</b>					
N1		<b>Puxador Pórtico</b> Handle Tirador	160 mm	<b>04</b>					
N5		<b>Suporte "L"</b> Support "L" Soporte "L"	-	<b>02</b>					
N6		<b>Capa</b> Cover Cubierta	-	<b>02</b>					
S		<b>Parafuso panela</b> Pan head screw Tornillo de pan	3,5x14 mm	<b>36</b>					

IDENTIFICAÇÃO DAS PEÇAS/ PARTS IDENTIFICATION/ IDENTIFICACIÓN DE LAS PIEZAS

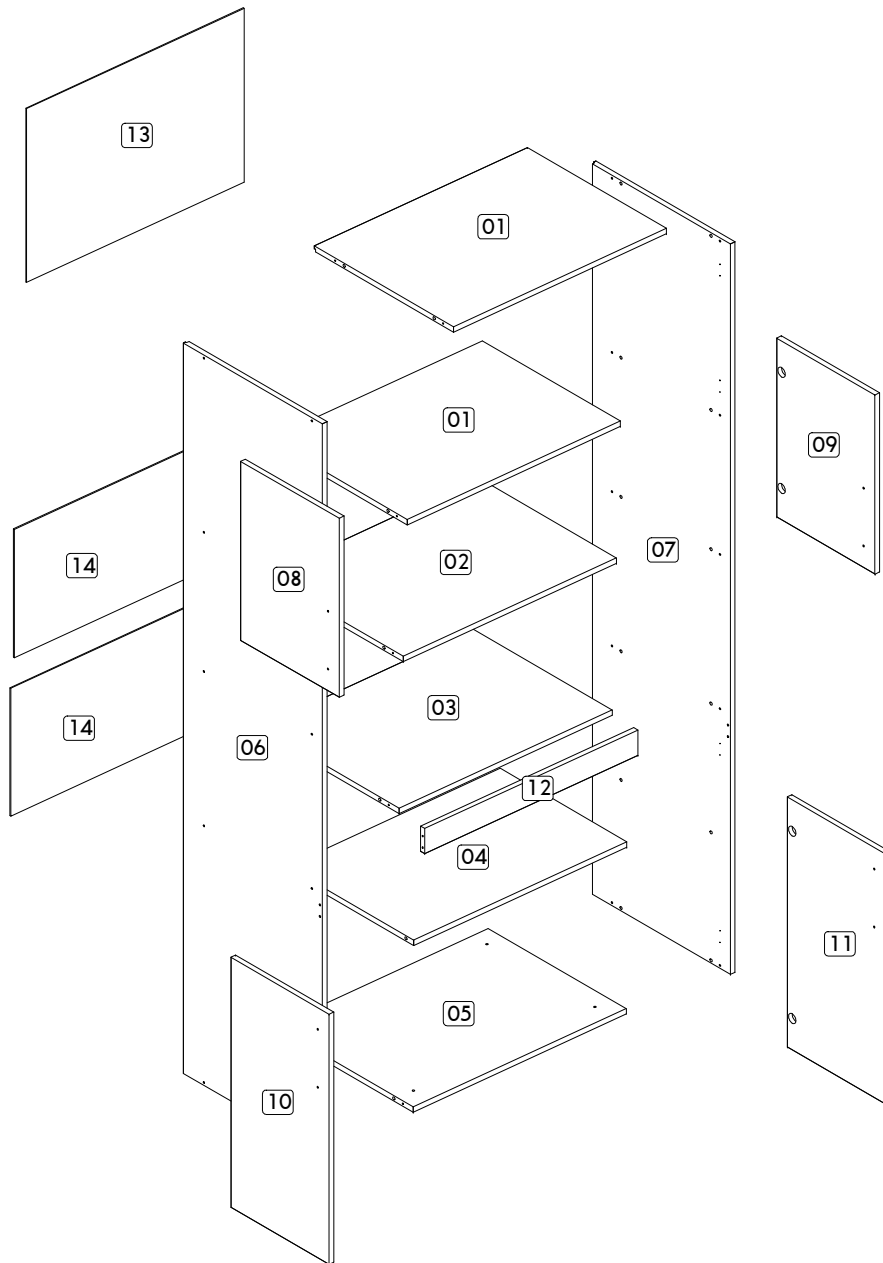

Nº	DESCRIÇÃO - DESCRIPTION - DESCRIPCIÓN	MEDIDAS-MEASURES - MEDIDAS (mm)	QTD.
01	<b>Base superior</b> - Top base - Base superior	675 x 495 x 15	02
02	<b>Prateleira central</b> - Center shelf - Repisa central	675 x 491 x 15	01
03	<b>Base intermediária</b> - Intermediate base - Base intermedia	675 x 495 x 15	01
04	<b>Prateleira</b> - Shelf - Repisa	675 x 450 x 15	01
05	<b>Base inferior</b> - Bottom base - Base inferior	675 x 495 x 15	01
06	<b>Lateral esquerda</b> - Left side - Lateral izquierda	2020 x 495 x 15	01
07	<b>Lateral direita</b> - Right side - Lateral derecha	2020 x 495 x 15	01
08	<b>Porta superior esquerda</b> - Upper left door - Puerta superior izquierda	495 x 349 x 15	01
09	<b>Porta superior direita</b> - Upper right door - Puerta superior derecha	495 x 349 x 15	01
10	<b>Porta inferior esquerda</b> - Bottom left door - Puerta inferior izquierda	692 x 349 x 15	01
11	<b>Porta inferior direita</b> - Bottom right door - Puerta inferior derecha	692 x 349 x 15	01
12	<b>Travessa</b> - Tray - Traviesa	675 x 70 x 15	01
13	<b>Costa superior</b> - Upper backboard - Fondo superior	689 x 481 x 3	01
14	<b>Costa inferior</b> - Bottom backboard - Fondo inferior	689 x 355 x 3	02

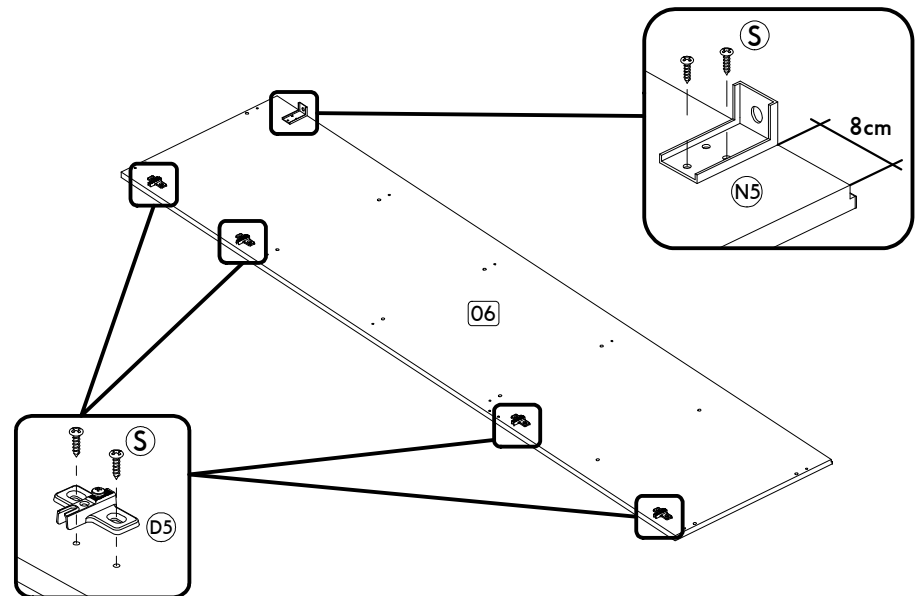
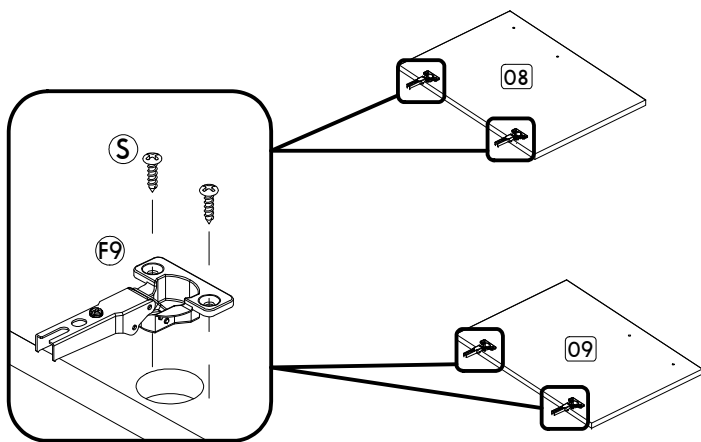
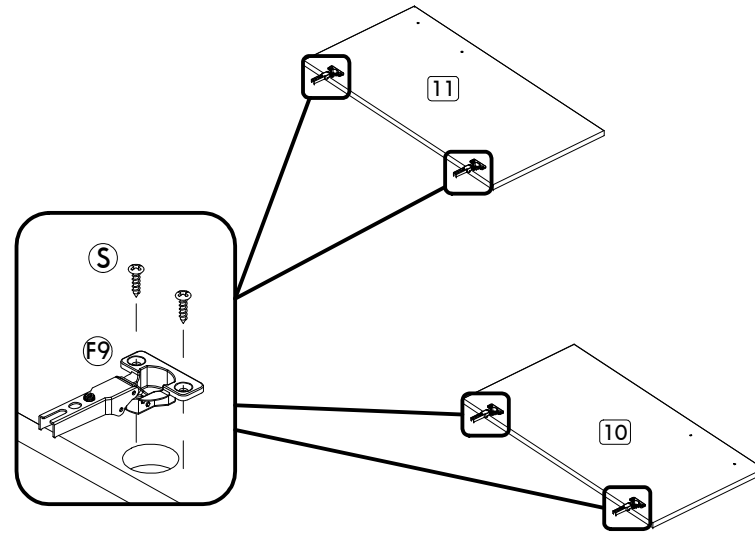
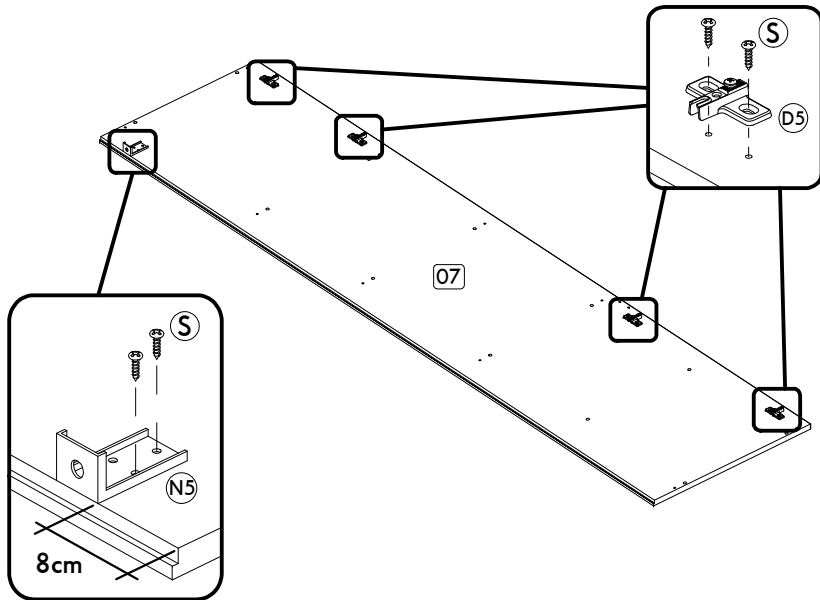

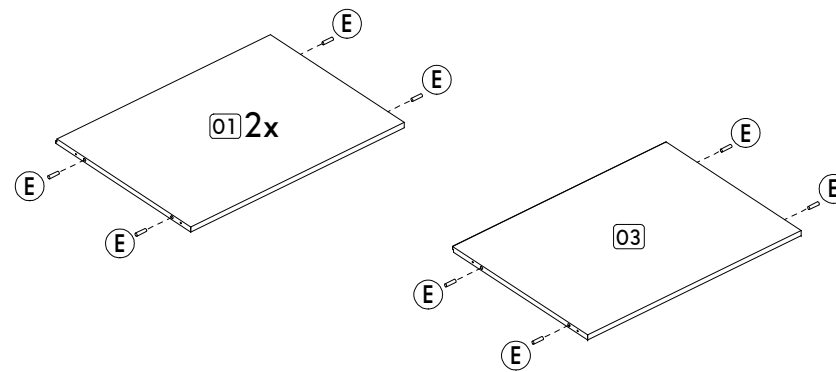
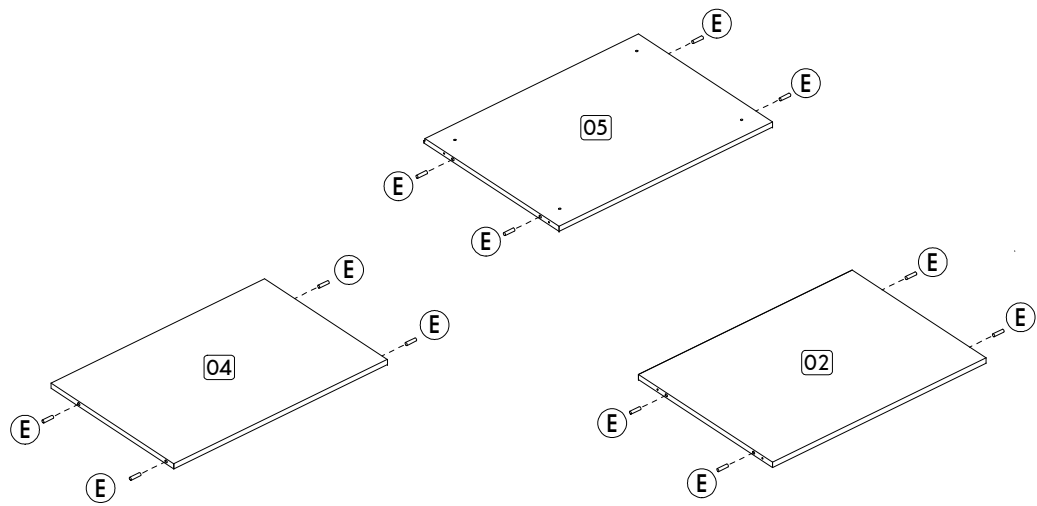

**MONTAGEM** / ASSEMBLY / ARMADO

Passo/ Step/ Paso **01**

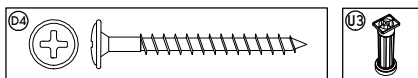
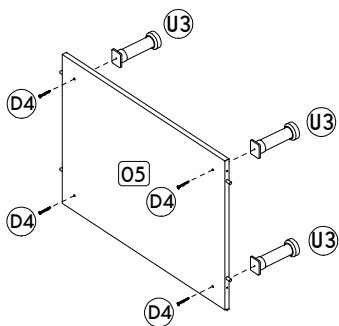

Passo/ Step/ Paso **02**

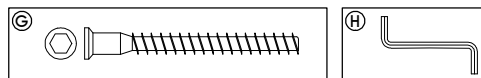
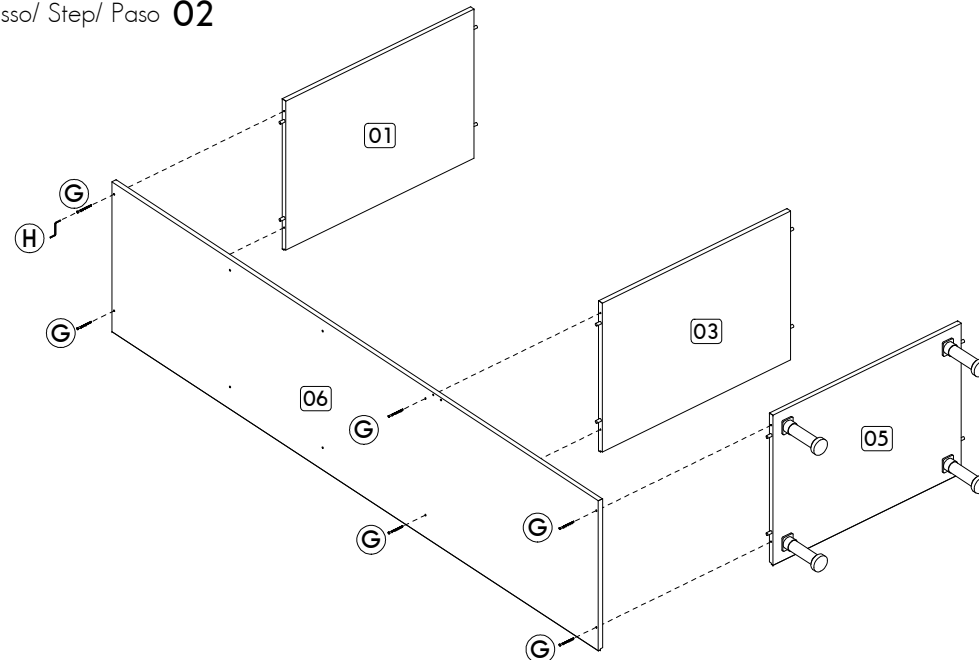

Passo/ Step/ Paso 03

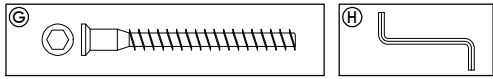
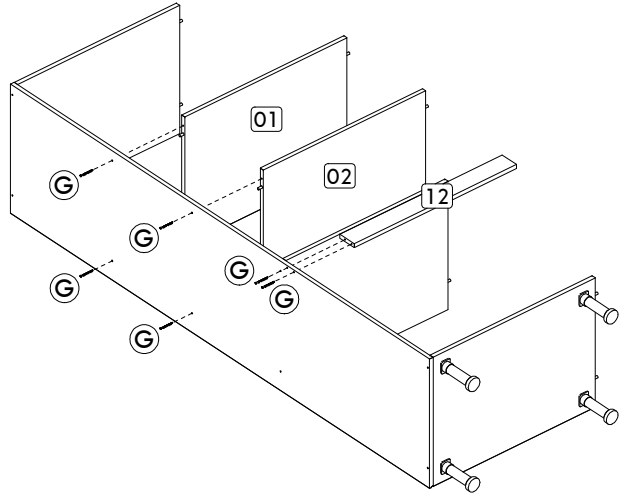

Passo/ Step/ Paso 04

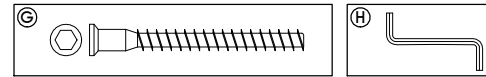
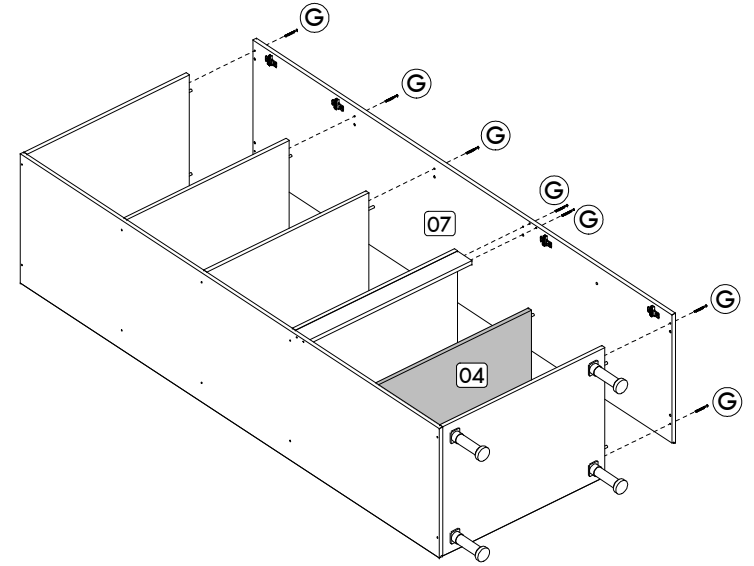

Passo/ Step/ Paso 05

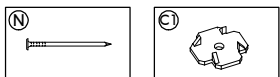
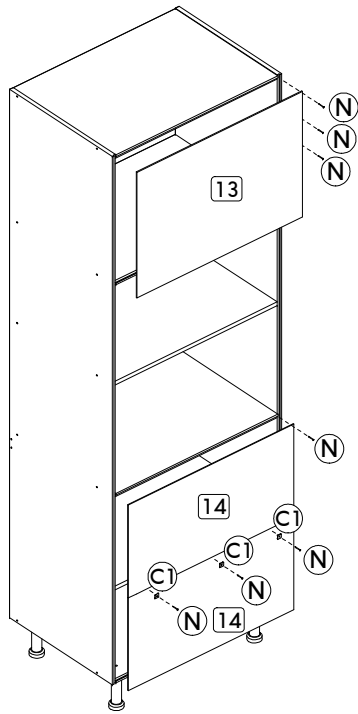

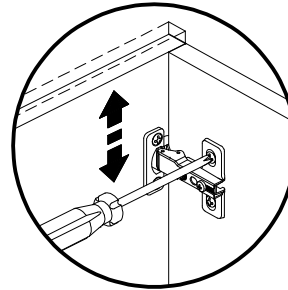
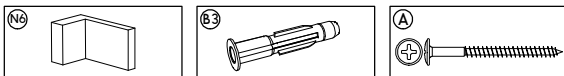
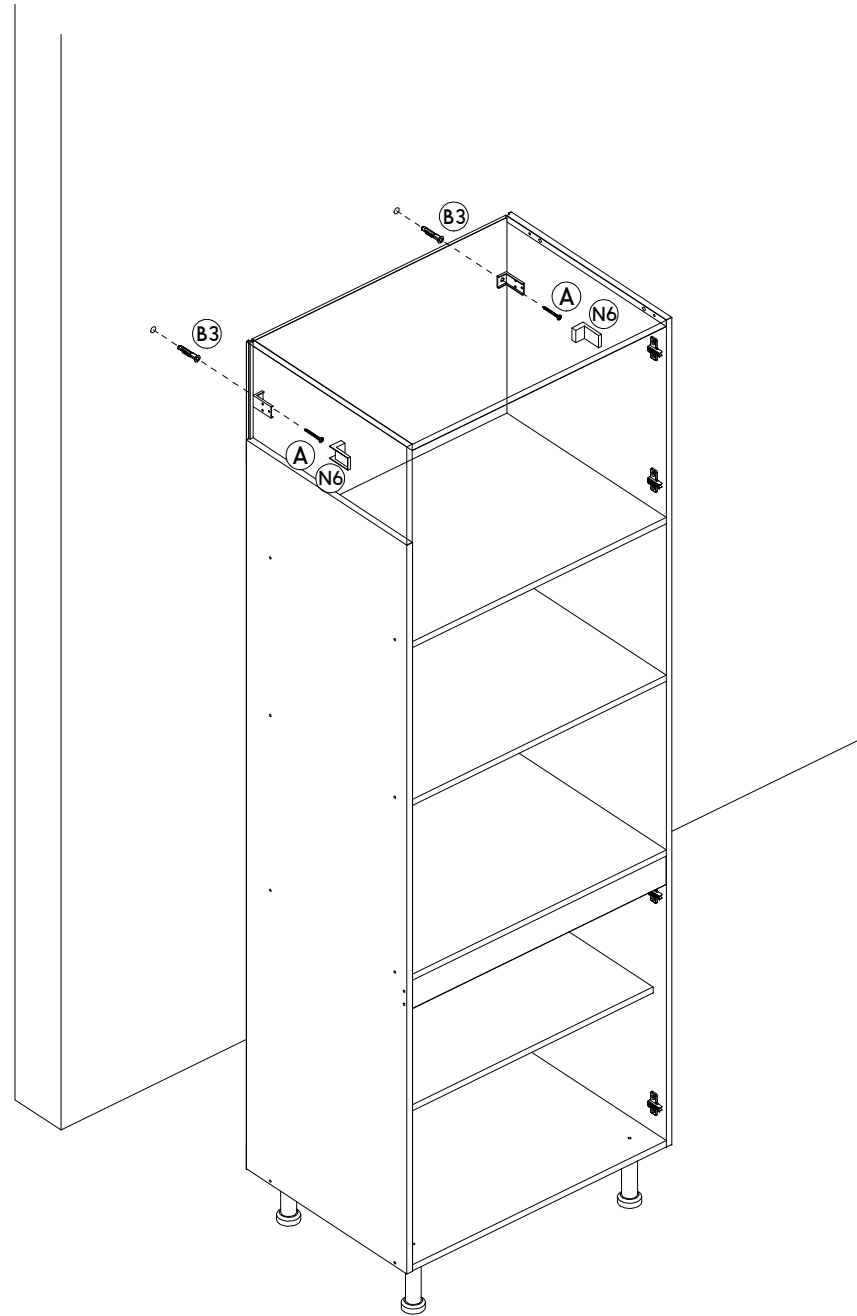

Regulagem Vertical  
Ajuste Vertical  
Vertical Adjustment

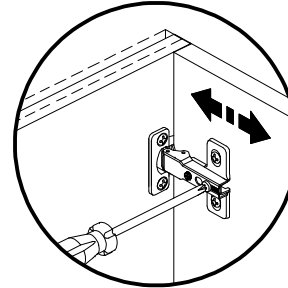

Regulagem Profundidade  
Ajuste Profundidad  
Depth Adjustment

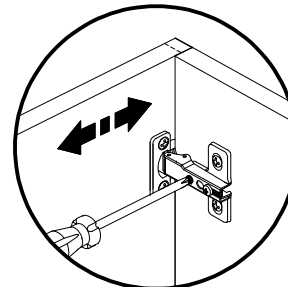

Regulagem Horizontal  
Ajuste Horizontal  
Horizontal Adjustment

